

## Introduction

TITAN tube fittings are constructed using the highest quality materials available in the industry. Fittings, valves, adapters and hose ends are precision machined and quality inspected prior to customer delivery. We strive to manufacture the best-in-class products in the flow control and hydraulics industry backed by excellent customer and technical support.

## Fitting Interchange

TITAN double ferrule tube fittings are interchangeable with Swagelok®, Parker A-Lok®, and Tylok CBC-Lok®. Although it is always recommended to use a fitting built with all TITAN components, inter mixing fitting components will not degrade the performance of the assembly.

## Assembly

TITAN double ferrule tube fittings are assembled using four individual components which include the body, the front ferrule, the back ferrule and the tube nut. All components are manufactured using high-grade stainless steel. Fittings are delivered pre-assembled and ready for installation.

## About Us

TITAN manufactures a full line of instrumentation grade fittings, valves, hose ends, quick connects and other fluid power components. TITAN has custom machining capability and is particularly strong suited to supply manufactured stainless steel components. TITAN also builds custom hose and tube assemblies which are quality inspected in house prior to delivery.

## Warranty

The TITAN warranty insures all tube fittings are manufactured without defect and are subject to immediate exchange if found to be deficient versus published specifications.

## Safety

High pressure fluid systems can be hazardous and all necessary precautions must be taken during installation and operation. Insure proper procedures and training is in place prior to the construction on any fluid circuit using TITAN tube fittings.

## Quality

TITAN tube fittings are manufactured under ISO 9001:2008 specifications.

## ORDERING TITAN FITTINGS BY PART NUMBERS:

The guide below describes how to build and order a particular TITAN tube fitting by part number.

### Example 1- Tube to Threaded End Fitting:

MC-4-4N



Where

MC: Fitting Type (Male NPT Connector)

-4: Tube Size (1/4" Tube)

-4N: Thread Size and Thread Type (1/4" NPT)

### Example 1- Tube End Only Fitting:

RU-4-2



Where

RU: Fitting Type (Reducing Union)

-4: Tube Size Side 1 (1/4" Tube)

-2: Tube Size Side 2 (1/4" Tube)

### Example 3- Tees:

Tee part numbers are described by the run (arms 1 & 2) then the branch (arm 3)

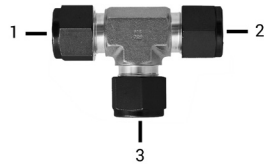

### Example 4- Crosses:

Cross part numbers are described by the run (arms 1 & 2) then the branches (arms 3 & 4)

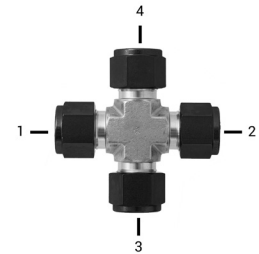

#### Tube O.D. Designator

Inch O.D	Identifier	Metric O.D	Identifier
1/16	1	2mm	2M
1/8	2	3mm	3M
3/16	3	4mm	4M
1/4	4	6mm	6M
5/16	5	8mm	8M
3/8	6	10mm	10M
1/2	8	12mm	12M
5/8	10	16mm	16M
3/4	12	20mm	20M
1/8	14	22mm	22M
1	16	25mm	25M
1-1/4	20	28mm	28M
1-1/2	24	32mm	32M
2	32	38mm	38M

#### Pipe Thread Size Designator

Nom. Size	Identifier
1/8"	2
1/4"	4
3/8"	6
1/2"	8
3/4"	12
1"	16
1-1/4"	20
1-1/2"	24
2"	32







#### Fitting Material Designator

Material	Identifier
SS316	S6
SS316L	6L
SS304	S4
Carbon Steel	CS
Brass	BS
Alloy400	MO







#### Pipe Thread Symbol

Type	Taper Threads		Parallel Threads	
Symbol	R	N	G	U
Specification	ISO 7/1, BS21(BSPT), JIS B 0203(PT), DIN2999	ANSI B1.20.1 (NPT)	ISO228/1, BS 2779(BSPP), JIS B0202(PF)	American Standard Unified Screw Threads



### Tube to Tube Union



Union <b>U-SF</b>		4
Union Elbow <b>L-SF</b>		5
Reducing Union <b>UR-SF</b>		6
Union Tee <b>T-SF</b>		7
Union Cross <b>X-SF</b>		8
Bulkhead Union <b>UB-SF</b>		9

### Tube to Male Pipe







Male Connector <b>MCN-SF</b>		10
Thermocouple Connector <b>MCT-SF</b>		11
Bulkhead Male Connector <b>MCB-SF</b>		11
45° Male Elbow <b>LBM-SF</b>		11
Male Elbow <b>LM-SF</b>		12
Male Run Tee <b>TRM-SF</b>		13
Male Branch Tee <b>TBM-SF</b>		14

### Tube to Female Pipe



Female Connector <b>CF-SF</b>		15
Bulkhead Female Connector <b>CBF-SF</b>		16

Female Elbow <b>LF-SF</b>		16
Female Run Tee <b>TRF-SF</b>		17
Female Branch Tee <b>TBF-SF</b>		18





### Stub Tube Connector



Reducer <b>R-SF</b>		19
Bulkhead Adapter <b>AB-SF</b>		20
Male Adapter <b>AM-SF</b>		21
Female Pipe Adapter <b>AF-SF</b>		22
Female BSPP Adapter <b>AG-SF</b>		23
Port Connector <b>CP-SF</b>		24
Reducing Port Connector <b>CRP-SF</b>		24

### Tube to AN Tube





AN Union <b>UA-SF</b>		25
AN Bulkhead Union <b>UBA-SF</b>		25
AN Adapter <b>AA-SF</b>		25

### Tube to SAE O-Ring Seal



SAE Male Connector <b>MCS-SF</b>		26
Positionable SAE Male Elbow <b>LS-SF</b>		26
Positionable 45° SAE Male Elbow <b>LBS-SF</b>		27
Positionable SAE Male Run Tee <b>TRS-SF</b>		27

Positionable SAE Male Branch Tee <b>TBS-SF</b>		27
O-Seal Straight Thread Connector <b>COS-SF</b>		28
O-Seal Pipe Thread Connector <b>COP-SF</b>		28





### Tube to Weld End

Male Pipe Weld Connector <b>CW-SF</b>		29
Male Pipe Weld Elbow <b>LW-SF</b>		29
Tube Socket Weld Connector <b>CSW-SF</b>		30
Tube Socket Weld Elbow <b>LSW-SF</b>		30
Welding Bulkhead Union <b>BUW-SF</b>		31

### Plug and Cap

Plug <b>P-SF</b>		32
Cap <b>C-SF</b>		32

### Spare Parts

Tube Insert <b>I-SF</b>		33
Nut <b>N-SF</b>		33
Ferrule <b>FO-SF</b>		34
Ferrule Set <b>FS-SF</b>		34

Disclaimer: Note that all the dimensions and specifications contained within this catalog are for a reference guide only and are subject to change at any time.

# U-SF Union

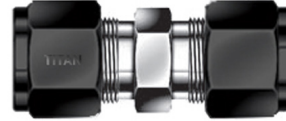
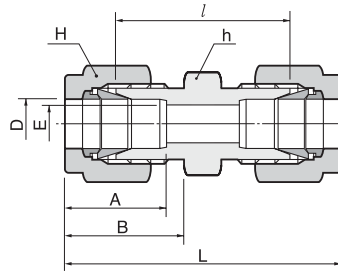

## Tube to Tube Union

Part No.	Tube O.D.		E min.	Width across flat				A	B	l	L
	D			h		H					
	in	mm		in	mm	in	mm				
U-SF-1	1/16	1.59	1.27	5/16	7.93	5/16	7.93	8.63	10.92	17.50	25.15
U-SF-2	1/8	3.17	2.28	7/16	11.11	7/16	11.11	12.70	15.24	22.35	35.56
U-SF-3	3/16	4.76	3.04	7/16	11.11	1/2	12.70	13.71	16.00	24.13	37.33
U-SF-4	1/4	6.35	4.82	1/2	12.70	9/16	14.28	15.24	17.78	26.16	40.89
U-SF-5	5/16	7.93	6.35	9/16	14.28	5/8	15.87	16.25	18.54	28.19	42.92
U-SF-6	3/8	9.52	7.11	5/8	15.87	11/16	17.46	16.76	19.30	30.22	44.95
U-SF-8	1/2	12.70	10.41	13/16	20.64	7/8	22.22	22.86	21.84	30.98	51.30
U-SF-10	5/8	15.87	12.70	15/16	23.81	1	25.40	24.38	21.84	31.75	52.07
U-SF-12	3/4	19.05	15.74	1-1/16	26.98	1-1/8	28.58	24.38	21.84	33.27	53.59
U-SF-14	7/8	22.22	18.28	1-3/16	30.16	1-1/4	31.75	25.90	21.84	35.05	55.37
U-SF-16	1	25.40	22.35	1-3/8	34.92	1-1/2	38.10	31.24	26.41	40.38	64.77
U-SF-20	1-1/4	31.75	27.68	1-3/4	44.45	1-7/8	50.80	41.14	38.86	48.00	92.20
U-SF-24	1-1/2	38.10	34.03	2-1/8	53.97	2-1/4	57.15	50.03	45.21	53.60	107.95
U-SF-32	2	50.80	45.97	2-3/4	69.85	3	76.20	67.56	62.73	74.70	149.35

# L-SF Union Elbow

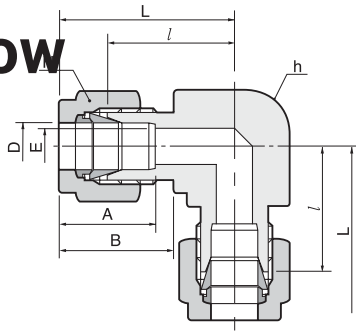

## Tube to Tube Union Elbow

Part No.	Tube O.D.		E min.	Width across flat				A	B	l	L
	D			h		H					
	in	mm		in	mm	in	mm				
L-SF-1	1/16	1.59	1.27	3/8	9.52	5/16	7.93	8.63	10.92	14.00	17.88
L-SF-2	1/8	3.17	2.28	3/8	9.52	7/16	11.11	12.70	15.24	15.74	22.35
L-SF-3	3/16	4.76	3.04	1/2	12.70	1/2	12.70	13.71	16.00	17.78	24.38
L-SF-4	1/4	6.35	4.82	1/2	12.70	9/16	14.28	15.24	17.78	19.55	26.92
L-SF-5	5/16	7.93	6.35	9/16	14.28	5/8	15.87	16.25	18.54	21.33	28.70
L-SF-6	3/8	9.52	7.11	5/8	15.87	11/16	17.46	16.76	19.30	23.11	30.48
L-SF-8	1/2	12.70	10.41	13/16	20.64	7/8	22.22	22.86	21.84	25.90	36.06
L-SF-10	5/8	15.87	12.70	15/16	23.81	1	25.40	24.38	21.84	28.70	38.80
L-SF-12	3/4	19.05	15.74	1-1/16	26.98	1-1/8	28.58	24.38	21.84	29.71	39.87
L-SF-14	7/8	22.22	18.28	1-1/4	31.75	1-1/4	31.75	25.90	21.84	34.54	44.70
L-SF-16	1	25.40	22.35	1-3/8	34.9	1-1/2	38.10	31.24	26.41	36.83	49.02
L-SF-20	1-1/4	31.75	27.68	1-11/16	42.86	1-7/8	50.80	41.14	38.86	44.50	66.54
L-SF-24	1-1/2	38.10	34.03	2	50.80	2-1/4	57.15	50.03	45.21	50.80	77.97
L-SF-32	2	50.80	45.97	2-3/4	69.85v	3	76.20	67.56	62.73	69.80	107.18

## UR-SF Reducing Union

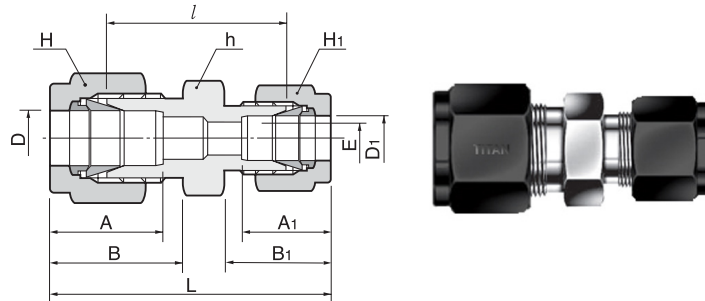

### Tube to Tube Reducing Union

Part No.	Tube O.D.				E Min.	Width across flat						A	A1	B	B1	l	L
	D		D1			h		H		H1							
	in	mm	in	mm		in	mm	in	mm	in	mm						
UR-SF-2-1	1/8	3.18	1/16	1.59	1.27	7/16	11.11	7/16	11.11	5/16	7.93	12.70	8.63	15.24	10.92	20.60	30.91
UR-SF-3-1	3/16	4.76	1/16	1.59	1.27	7/16	11.11	1/2	12.70	5/16	7.93	13.71	8.63	16.00	10.92	21.84	32.25
UR-SF-3-2	3/16	4.76	1/8	3.17	2.28	7/16	11.11	1/2	12.70	7/16	11.11	13.71	12.70	16.00	15.24	23.36	36.57
UR-SF-4-1	1/4	6.35	1/16	1.59	1.27	1/2	12.70	9/16	14.28	5/16	7.93	15.24	8.63	17.78	10.92	23.11	34.29
UR-SF-4-2	1/4	6.35	1/8	3.17	2.28	1/2	12.70	9/16	14.28	7/16	11.11	15.24	12.70	17.78	15.24	24.63	38.60
UR-SF-4-3	1/4	6.35	3/16	4.76	3.04	1/2	12.70	9/16	14.28	1/2	12.70	15.74	13.71	17.78	16.00	25.40	39.37
UR-SF-5-2	5/16	7.93	1/8	3.17	2.28	9/16	14.28	5/8	15.87	7/16	11.11	16.25	12.70	18.54	15.24	25.90	39.87
UR-SF-5-4	5/16	7.93	1/4	6.35	4.82	9/16	14.28	5/8	15.87	9/16	14.28	16.25	15.24	18.54	17.78	27.43	42.16
UR-SF-6-1	3/8	9.52	1/16	1.59	1.27	5/8	15.87	11/16	17.46	5/8	15.87	16.76	8.63	19.30	15.24	25.40	36.57
UR-SF-6-2	3/8	9.52	1/8	3.17	2.28	5/8	15.87	11/16	17.46	7/16	11.11	16.76	12.70	19.30	17.78	26.92	40.89
UR-SF-6-4	3/8	9.52	1/4	6.35	4.82	5/8	15.87	11/16	17.46	9/16	14.28	16.76	15.24	19.30	19.30	28.44	43.18
UR-SF-6-5	3/8	9.52	5/16	7.93	6.35	5/8	15.87	11/16	17.46	5/8	15.87	16.76	16.25	19.30	19.30	29.46	44.19
UR-SF-8-2	1/2	12.70	1/8	3.17	2.28	13/16	20.64	7/8	22.22	7/16	11.11	22.86	12.70	21.84	21.84	28.44	45.21
UR-SF-8-4	1/2	12.70	1/4	6.35	4.82	13/16	20.64	7/8	22.22	9/16	14.48	22.86	15.24	21.84	17.78	29.46	46.99
UR-SF-32	1/2	12.70	3/8	9.52	7.11	13/16	20.64	7/8	22.22	11/16	17.46	22.86	16.76	21.84	19.30	30.98	48.51
UR-SF-32	5/8	15.87	3/8	9.52	7.11	15/16	23.81	1	25.40	11/16	17.46	24.38	16.76	21.84	19.30	31.75	49.27
UR-SF-10-8	5/8	15.87	1/2	12.70	10.41	15/16	23.81	1	25.40	7/8	22.22	24.38	22.86	21.84	21.84	31.75	52.07
UR-SF-12-4	3/4	19.05	1/4	6.35	4.82	1-1/16	26.98	1-1/8	28.57	9/16	14.48	24.38	15.24	21.84	17.78	31.75	49.27
UR-SF-12-6	3/4	19.05	3/8	9.52	7.11	1-1/16	26.98	1-1/8	28.57	11/16	17.46	24.38	16.76	21.84	19.30	33.27	50.80
UR-SF-12-8	3/4	19.05	1/2	12.70	10.41	1-1/16	26.98	1-1/8	28.57	7/8	22.22	24.38	22.86	21.84	21.84	33.27	53.59
UR-SF-12-10	3/4	19.05	5/8	15.87	12.70	1-1/16	26.98	1-1/8	28.57	1	25.40	24.38	24.38	21.84	21.84	33.27	53.39
UR-SF-16-8	1	25.40	1/2	12.70	10.41	1-3/8	34.92	1-1/2	38.10	7/8	22.22	31.24	22.86	26.41	21.84	40.89	63.24
UR-SF-16-12	1	25.40	3/4	19.05	15.74	1-3/8	34.92	1-1/2	38.10	1-1/8	28.58	31.24	24.38	26.41	21.84	40.38	62.73

# T-SF Union Tee

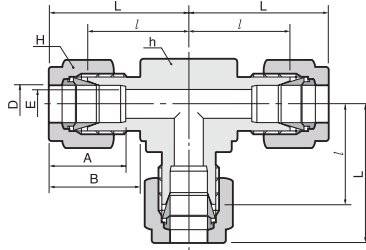

## Tube to Tube Union Tee

Part No.	Tube O.D.		E Min.	Width across flat				A	B	l	L
	D			h		H					
	in	mm		in	mm	in	mm				
T-SF-1	1/16	1.59	1.27	3/8	9.52	5/16	7.93	8.63	10.92	14.00	17.88
T-SF-2	1/8	3.17	2.28	3/8	9.52	7/16	11.11	12.70	15.24	15.74	22.35
T-SF-3	3/16	4.76	3.04	1/2	12.70	1/2	12.70	13.71	16.00	17.78	24.38
T-SF-4	1/4	6.35	4.82	1/2	12.70	9/16	14.28	15.24	17.78	19.55	26.92
T-SF-5	5/16	7.93	6.35	9/16	14.28	5/8	15.87	16.25	18.54	21.33	28.70
T-SF-6	3/8	9.52	7.11	5/8	15.87	11/16	17.46	16.76	19.30	23.11	30.48
T-SF-8	1/2	12.70	10.41	13/16	20.64	7/8	22.22	22.86	21.84	25.90	36.06
T-SF-10	5/8	15.87	12.70	15/16	23.81	1	25.40	24.38	21.84	28.70	38.80
T-SF-12	3/4	19.05	15.74	1-1/16	26.98	1-1/8	28.58	24.38	21.84	29.71	39.87
T-SF-14	7/8	22.22	18.28	1-1/4	31.75	1-1/4	31.75	25.90	21.84	34.54	44.70
T-SF-16	1	25.40	22.35	1-3/8	34.9	1-1/2	38.10	31.24	26.41	36.83	49.02
T-SF-20	1-1/4	31.75	27.68	1-11/16	42.86	1-7/8	47.63	41.14	38.86	44.50	66.54
T-SF-24	1-1/2	38.10	34.03	2	50.80	2-1/4	57.15	50.03	45.21	50.80	77.97
T-SF-32	2	50.80	45.97	2 3/4	69.85	3	76.20	67.56	62.73	69.80	107.18

# X-SF Union Cross

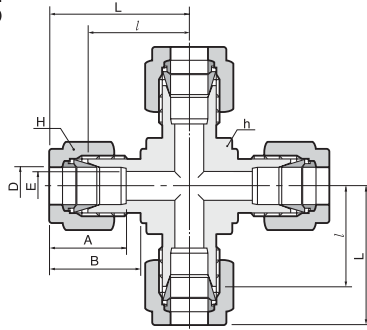

## Tube to Tube Union Cross

Part No.	Tube O.D.		E Min.	Width across flat				A	B	l	L
	D			h		H					
	in	mm		in	mm	in	mm				
X-SF-1	1/16	1.59	1.27	3/8	9.52	5/16	7.93	8.63	10.92	14.00	17.88
X-SF-2	1/8	3.17	2.28	3/8	9.52	7/16	11.11	12.70	15.24	15.74	22.35
X-SF-3	3/16	4.76	3.04	1/2	12.70	1/2	12.70	13.71	16.00	17.78	24.38
X-SF-4	1/4	6.35	4.82	1/2	12.70	9/16	14.28	15.24	17.78	19.55	26.92
X-SF-5	5/16	7.93	6.35	1/2	12.70	5/8	15.87	16.25	18.54	21.33	28.70
X-SF-6	3/8	9.52	7.11	11/16	17.46	11/16	17.46	16.76	19.30	23.11	30.48
X-SF-8	1/2	12.70	10.41	13/16	20.64	7/8	22.22	22.86	21.84	25.90	36.06
X-SF-10	5/8	15.87	12.70	13/16	20.64	1	25.40	24.38	21.84	28.70	38.80
X-SF-12	3/4	19.05	15.74	1	25.40	1-1/8	28.58	24.38	21.84	29.71	39.87
X-SF-14	7/8	22.22	18.28	1-1/4	31.75	1-1/4	31.75	25.90	21.84	34.54	44.70
X-SF-16	1	25.40	22.35	1-27/64	36.12	1-1/2	38.10	31.24	26.41	36.83	49.02
X-SF-20	1-1/4	31.75	27.68	1-11/16	42.86	1-7/8	47.63	41.14	38.86	44.50	66.54
X-SF-24	1-1/2	38.10	34.03	2	50.80	2-1/4	57.15	50.03	45.21	50.80	77.97
X-SF-32	2	50.80	45.97	2-3/4	69.85	3	76.20	67.56	62.73	69.80	107.18



# UB-SF Bulkhead Union

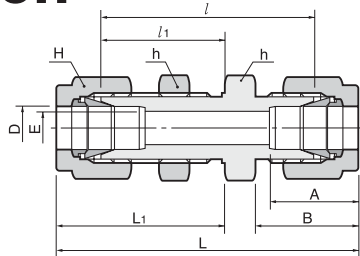

## Tube to Tube Bulkhead Union

Part No.	Tube O.D.		E Min.	Width across flat				A	B	l	l1	L	L1	Panel Hole Drill size	Panel Max Thickness
	D in	mm		h in	mm	H in	mm								
UB-SF-1	1/16	1.59	1.27	5/16	7.93	5/16	7.93	8.63	10.92	23.87	13.46	31.50	17.27	5.16	3.05
UB-SF-2	1/8	3.17	2.28	1/2	12.70	7/16	11.11	12.70	15.24	38.10	24.63	51.30	31.24	8.33	12.70
UB-SF-3	3/16	4.76	3.04	9/16	14.28	1/2	12.70	13.71	16.00	40.38	25.40	53.59	32.00	9.92	12.70
UB-SF-4	1/4	6.35	4.82	5/8	15.87	9/16	14.28	15.24	17.78	42.92	26.16	57.65	33.52	11.50	10.16
UB-SF-5	5/16	7.93	6.35	11/16	17.46	5/8	15.87	16.25	18.54	45.97	28.44	60.70	35.81	13.09	11.17
UB-SF-6	3/8	9.52	7.11	3/4	19.05	11/16	17.46	16.76	19.30	47.49	29.46	62.23	36.83	14.68	11.17
UB-SF-8	1/2	12.70	10.41	15/16	23.81	7/8	22.22	22.86	21.84	50.80	31.75	71.12	41.91	19.44	12.70
UB-SF-10	5/8	15.87	12.70	1-1/16	26.98	1	25.40	24.38	21.84	52.32	32.51	72.64	42.67	22.62	12.70
UB-SF-12	3/4	19.05	15.74	1-3/16	30.16	1-1/8	28.58	24.38	21.84	58.67	37.33	78.99	47.49	25.79	16.76
UB-SF-14	7/8	22.22	18.28	1-3/8	34.92	1-1/4	31.75	25.90	21.84	64.26	42.92	84.58	53.08	28.97	19.05
UB-SF-16	1	25.40	22.35	1-5/8	41.27	1-1/2	38.10	31.24	26.41	71.37	45.21	95.75	57.40	33.73	19.05
UB-SF-20	1-1/4	31.75	27.68	1-7/8	47.63	1-7/8	47.63	41.14	38.86	78.99	47.75	123.19	69.85	41.67	19.05
UB-SF-24	1-1/2	38.10	34.03	2-1/4	57.15	2-1/4	57.15	50.03	45.21	84.83	49.27	139.19	76.45	49.61	19.05
UB-SF-32	2	50.80	45.97	2-3/4	69.85	3	76.20	67.56	62.73	105.66	56.38	180.34	93.72	57.94	19.05

# MCN-SF Male Connector

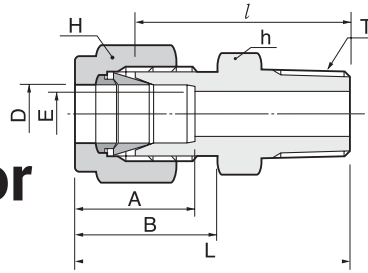

## Tube to Male NPT Connector

Part No.	Tube O.D. D		T (NPT)	E Min.	Width across flat				A	B	l	L
	in	mm			h	mm	in	mm				
MC-SF-1-1N	1/16	1.59	1/16	1.27	5/16	7.93	5/16	7.93	8.63	10.92	20.00	23.83
MC-SF-1-2N	1/16	1.59	1/8	1.27	7/16	11.11	5/16	7.93	8.63	10.92	22.35	26.23
MC-SF-1-4N	1/16	1.59	1/4	1.27	9/16	14.28	5/16	7.93	8.63	10.92	27.17	30.98
MC-SF-2-1N	1/8	3.17	1/16	2.28	7/16	11.11	7/16	11.11	12.70	15.24	23.11	29.71
MC-SF-2-2N	1/8	3.17	1/8	2.28	7/16	11.11	7/16	11.11	12.70	15.24	23.87	30.48
MC-SF-2-4N	1/8	3.17	1/4	2.28	9/16	14.28	7/16	11.11	12.70	15.24	28.95	35.56
MC-SF-2-6N	1/8	3.17	3/8	2.28	11/16	17.46	7/16	11.11	12.70	15.24	29.21	35.81
MC-SF-2-8N	1/8	3.17	1/2	2.28	7/8	22.22	7/16	11.11	12.70	15.24	35.56	42.16
MC-SF-3-2N	3/16	4.76	1/8	3.04	7/16	11.11	1/2	12.70	13.71	16.00	24.63	31.24
MC-SF-3-4N	3/16	4.76	1/4	3.04	9/16	14.28	1/2	12.70	13.71	16.00	29.71	36.32
MC-SF-4-1N	1/4	6.35	1/16	4.82	1/2	12.70	9/16	14.28	15.24	17.78	25.40	32.76
MC-SF-4-2N	1/4	6.35	1/8	4.82	1/2	12.70	9/16	14.28	15.24	17.78	25.40	32.76
MC-SF-4-4N	1/4	6.35	1/4	4.82	9/16	14.28	9/16	14.28	15.24	17.78	30.48	37.84
MC-SF-4-6N	1/4	6.35	3/8	4.82	11/16	17.46	9/16	14.28	15.24	17.78	30.98	38.35
MC-SF-4-8N	1/4	6.35	1/2	4.82	7/8	22.22	9/16	14.28	15.24	17.78	37.33	44.70
MC-SF-4-12N	1/4	6.35	3/4	4.82	1 1/16	26.98	9/16	14.28	15.24	17.78	38.86	46.22
MC-SF-5-2N	5/16	7.93	1/8	4.82	9/16	14.28	5/8	15.87	16.25	18.54	26.67	34.03
MC-SF-5-4N	5/16	7.93	1/4	6.35	9/16	14.28	5/8	15.87	16.25	18.54	31.24	38.60
MC-SF-5-6N	5/16	7.93	3/8	6.35	11/16	17.46	5/8	15.87	16.25	18.54	31.75	39.11
MC-SF-5-8N	5/16	7.93	1/2	6.35	7/8	22.22	5/8	15.87	16.25	18.54	38.11	45.60
MC-SF-6-2N	3/8	9.52	1/8	4.82	5/8	15.87	11/16	17.46	16.76	19.30	27.94	35.30
MC-SF-6-4N	3/8	9.52	1/4	7.11	5/8	15.87	11/16	17.46	16.76	19.30	32.51	39.87
MC-SF-6-6N	3/8	9.52	3/8	7.11	11/16	17.46	11/16	17.46	16.76	19.30	32.51	39.87
MC-SF-6-8N	3/8	9.52	1/2	7.11	7/8	22.22	11/16	17.46	16.76	19.30	38.86	46.22
MC-SF-6-12N	3/8	9.52	3/4	7.11	1-1/16	26.98	11/16	17.46	16.76	19.30	40.38	47.75
MC-SF-8-2N	1/2	12.70	1/8	4.82	13/16	20.64	7/8	22.22	22.86	21.84	28.70	38.86
MC-SF-8-4N	1/2	12.70	1/4	7.11	13/16	20.64	7/8	22.22	22.86	21.84	33.27	43.43
MC-SF-8-6N	1/2	12.70	3/8	9.65	13/16	20.64	7/8	22.22	22.86	21.84	33.27	43.43
MC-SF-8-8N	1/2	12.70	1/2	10.41	7/8	22.22	7/8	22.22	22.86	21.84	38.86	49.02
MC-SF-8-12N	1/2	12.70	3/4	10.41	1-1/16	26.98	7/8	22.22	22.86	21.84	40.38	50.54
MC-SF-8-16N	1/2	12.70	1	10.41	1-3/8	34.92	7/8	22.22	22.86	21.84	46.99	57.15
MC-SF-10-6N	5/8	15.87	3/8	9.65	15/16	23.81	1	25.40	24.38	21.84	34.03	44.19
MC-SF-10-8N	5/8	15.87	1/2	11.93	15/16	23.81	1	25.40	24.38	21.84	38.86	49.02
MC-SF-10-12N	5/8	15.87	3/4	12.70	1-1/16	26.98	1	25.40	24.38	21.84	40.38	50.54
MC-SF-12-8N	3/4	19.05	1/2	11.93	1-1/16	26.98	1-1/8	28.58	24.38	21.84	40.38	50.54
MC-SF-12-12N	3/4	19.05	3/4	15.74	1-1/16	26.98	1-1/8	28.58	24.38	21.84	40.38	50.54
MC-SF-12-16N	3/4	19.05	1	15.74	1-3/8	34.92	1-1/8	28.58	24.38	21.84	46.99	57.15
MC-SF-14-12N	7/8	22.22	3/4	15.74	1-3/16	30.16	1-1/4	31.75	25.90	21.84	40.38	50.54
MC-SF-14-16N	7/8	22.22	1	18.28	1-3/8	34.92	1-1/4	31.75	25.90	21.84	46.99	57.15
MC-SF-16-8N	1	25.40	1/2	11.93	1-3/8	34.92	1-1/2	38.10	31.24	26.41	45.21	57.40
MC-SF-16-12N	1	25.40	3/4	15.74	1-3/8	34.92	1-1/2	38.10	31.24	26.41	45.21	57.40
MC-SF-16-16N	1	25.40	1	22.35	1-3/8	34.92	1-1/2	38.10	31.24	26.41	50.03	62.23
MC-SF-20-16N	-1/4	31.75	1	22.35	1-3/4	44.45	1-7/8	47.63	41.14	38.86	55.11	77.21
MC-SF-20-20N	-1/4	31.75	1-1/4	27.68	1-3/4	44.45	1-7/8	47.63	41.14	38.86	55.11	77.21
MC-SF-20-24N	-1/4	31.75	1-1/2	27.68	1-3/4	44.45	1-7/8	47.63	41.14	38.86	60.54	82.64
MC-SF-24-20N	-1/2	38.10	1-1/4	27.68	2-1/8	53.98	2-1/4	57.15	50.03	45.21	59.42	86.60
MC-SF-24-24N	-1/2	38.10	1-1/2	34.03	2-1/8	53.98	2-1/4	57.15	50.03	45.21	61.72	88.90
MC-SF-24-32N	-1/2	38.10	2	34.03	2-3/4	69.85	2-1/4	57.15	50.03	45.21	62.42	99.75
MC-SF-32-8N	2	50.80	1/2	11.93	2-3/4	69.85	3	76.20	67.56	62.73	68.40	105.73
MC-SF-32-20N	2	50.80	1-1/4	45.97	2-3/4	69.85	3	76.20	67.56	62.73	71.40	108.73
MC-SF-32-24N	2	50.80	1-1/2	45.97	2-3/4	69.85	3	76.20	67.56	62.73	75.50	112.83
MC-SF-32-32N	2	50.80	2	45.97	2 3/4	69.85	3	76.20	67.56	62.73	76.20	113.53

# MCT-SF

## Thermocouple Connector

TITAN thermocouple connector (the MCT) is designed to enable a thermocouple to slide all the way through to the fittings threaded end. This is done by machining out the shoulder and size angle inside the fitting body. The part number changes as follows:

MCT-8-8N-S is a 1/2" OD x 1/2" NPT Thermocouple connector

Assembly notes:

1. Slide the full length of the thermocouple through the fitted body and hold it in place.
2. Turn the Nut 1-1/4 turns past finger tight with a wrench while holding the body. Back the wrench 1/4 turn for sizes 1/4" and above.

# MCB-SF

## Bulkhead Male Connector

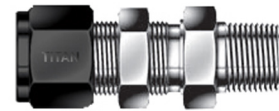
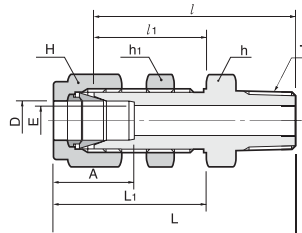

### Tube to Male NPT Bulkhead Connector

Part No.	Tube O.D.		T (NPT)	E Min.	Width across flat						A	l	l <sub>1</sub>	L	L <sub>1</sub>	Panel Hole Drill size	Panel Max Thickness
	in	mm			h	mm	in	mm	h <sub>1</sub>	mm							
MCB-SF-2-2N	1/8	3.17	1/8	2.28	1/2	12.70	1/2	12.70	7/16	11.11	12.70	39.87	24.63	46.48	31.24	8.33	12.70
MCB-SF-4-2N	1/4	6.35	1/8	4.82	5/8	15.87	5/8	15.87	9/16	14.28	15.24	42.16	26.16	49.53	33.52	11.50	10.16
MCB-SF-4-4N	1/4	6.35	1/4	4.82	5/8	15.87	5/8	15.87	9/16	14.28	15.24	45.97	26.16	53.34	33.52	11.50	10.16
MCB-SF-6-4N	3/8	9.52	1/4	7.11	3/4	19.05	3/4	19.05	11/16	17.46	16.76	50.03	29.46	57.40	36.83	14.68	11.17
MCB-SF-6-6N	3/8	9.52	3/8	7.11	3/4	19.05	3/4	19.05	11/16	17.46	16.76	50.03	29.46	57.40	36.83	14.68	11.17
MCB-SF-6-8N	3/8	9.52	1/2	7.11	7/8	22.22	3/4	19.05	11/16	17.46	16.76	56.38	29.46	63.75	36.83	14.68	11.17
MCB-SF-8-6N	1/2	12.70	3/8	9.39	15/16	23.81	15/16	23.81	7/8	22.22	22.86	53.08	31.75	63.24	41.91	19.44	12.70
MCB-SF-8-8N	1/2	12.70	1/2	10.41	15/16	23.81	15/16	23.81	7/8	22.22	22.86	58.67	31.75	68.83	41.91	19.44	12.70
MCB-SF-12-12N	3/4	19.05	3/4	15.74	1-3/16	30.16	1-3/16	30.16	1-1/8	28.58	24.38	66.04	37.33	76.20	47.49	25.76	16.76
MCB-SF-16-16N	1	25.40	1	22.35	1-5/8	41.28	1-5/8	41.28	1-1/2	38.10	31.24	81.02	45.21	93.21	57.40	33.73	19.05
MCB-SF-20-20N	1-1/4	31.75	1-1/4	27.68	1-7/8	47.63	1-7/8	47.63	1-7/8	47.63	41.14	85.97	47.75	108.07	69.85	41.67	19.05
MCB-SF-24-24N	1-1/2	38.10	1-1/2	34.03	2-1/4	57.15	2-1/4	57.15	2-1/4	57.15	50.03	93.03	49.27	120.21	76.45	49.61	19.05
MCB-SF-32-32N	2	50.80	2	45.97	2-3/4	69.85	2-3/4	69.85	3	76.20	67.56	107.29	56.38	144.62	93.71	16.27	19.05

# LBM-SF

## 45° Male Elbow

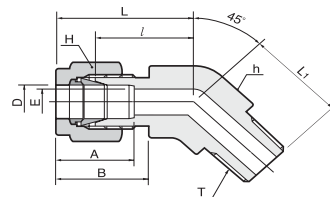

### Tube to Male NPT 45° Elbow

Part No.	Tube O.D.		T (NPT)	E Min.	Width across flat						A	B	l	L	L <sub>1</sub>
	in	mm			h	mm	in	mm	H	mm					
LBM-SF -4-2N	1/4	6.35	1/8	4.82	1/2	12.70	9/16	14.28	15.24	17.78	17.27	24.63	16.51		
LBM-SF -4-4N	1/4	6.35	1/4	4.82	1/2	12.70	9/16	14.28	15.24	17.78	17.27	24.63	21.08		
LBM-SF -6-2N	3/8	9.52	1/8	4.82	5/8	15.87	11/16	17.46	16.76	19.30	20.57	27.94	18.28		
LBM-SF -6-4N	3/8	9.52	1/4	7.11	5/8	15.87	11/16	17.46	16.76	19.30	20.57	27.94	22.86		
LBM-SF -6-6N	3/8	9.52	3/8	7.11	11/16	17.46	11/16	17.46	16.76	19.30	21.84	29.21	24.13		
LBM-SF -8-6N	1/2	12.70	3/8	9.65	13/16	20.64	7/8	22.22	22.86	21.84	21.84	32.00	24.13		
LBM-SF -8-8N	1/2	12.70	1/2	10.41	13/16	20.64	7/8	22.22	22.86	21.84	21.84	32.00	28.95		
LBM-SF -12-12N	3/4	19.05	3/4	15.74	1-1/16	26.98	1-1/8	28.58	24.38	21.84	23.87	34.03	30.98		
LBM-SF -16-16N	1	25.40	1	22.35	1-3/8	34.93	1-1/2	38.10	31.24	26.41	28.19	40.38	37.84		

# LM-SF Male Elbow

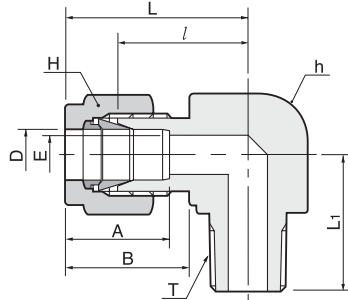

## Tube to Male NPT 90° Elbow

Part No.	Tube O.D.		T (NPT)	E Min.	Width across flat				A	B	l	L	L <sub>1</sub>
	D				h	H							
	in	mm					in	mm					
LM-SF-1-1N	1/16	1.59	1/16	1.27	7/16	11.11	5/16	7.93	8.63	10.92	15.24	19.05	17.78
LM-SF-1-2N	1/16	1.59	1/8	1.27	7/16	11.11	5/16	7.93	8.63	10.92	15.24	19.05	17.78
LM-SF-2-2N	1/8	3.17	1/8	2.28	1/2	12.70	7/16	11.11	12.70	15.24	18.30	24.91	18.90
LM-SF-2-4N	1/8	3.17	1/4	2.28	1/2	12.70	7/16	11.11	12.70	15.24	18.30	24.91	23.36
LM-SF-3-2N	3/16	4.76	1/8	3.04	1/2	12.70	1/2	12.70	13.71	16.00	18.79	25.40	18.79
LM-SF-3-4N	3/16	4.76	1/4	3.04	1/2	12.70	1/2	12.70	13.71	16.00	18.79	25.40	23.36
LM-SF-4-1N	1/4	6.35	1/16	3.04	1/2	12.70	9/16	14.28	15.24	17.78	19.55	26.90	18.79
LM-SF-4-2N	1/4	6.35	1/8	4.82	1/2	12.70	9/16	14.28	15.24	17.78	19.10	26.47	19.10
LM-SF-4-4N	1/4	6.35	1/4	4.82	1/2	12.70	9/16	14.28	15.24	17.78	19.81	27.18	23.87
LM-SF-4-6N	1/4	6.35	3/8	4.82	11/16	17.46	9/16	14.28	15.24	17.78	22.35	29.71	26.20
LM-SF-4-8N	1/4	6.35	1/2	4.82	13/16	20.64	9/16	14.28	15.24	17.78	24.60	31.97	33.02
LM-SF-5-2N	5/16	7.93	1/8	4.82	9/16	14.28	5/8	15.87	16.25	18.54	21.33	28.70	19.81
LM-SF-5-4N	5/16	7.93	1/4	6.35	9/16	14.28	5/8	15.87	16.25	18.54	21.33	29.77	24.50
LM-SF-5-6N	5/16	7.93	3/8	6.35	11/16	17.46	5/8	15.87	16.25	18.54	23.11	30.48	26.20
LM-SF-6-2N	3/8	9.52	1/8	4.82	5/8	15.87	11/16	17.46	16.76	19.30	23.11	30.48	20.60
LM-SF-6-4N	3/8	9.52	1/4	7.11	5/8	15.87	11/16	17.46	16.76	19.30	23.11	30.48	25.40
LM-SF-6-6N	3/8	9.52	3/8	7.11	11/16	17.46	11/16	17.46	16.76	19.30	23.87	31.24	26.20
LM-SF-6-8N	3/8	9.52	1/2	7.11	13/16	20.64	11/16	17.46	16.76	19.30	25.90	31.42	33.02
LM-SF-6-12N	3/8	9.52	3/4	7.11	1-1/16	26.98	11/16	17.46	16.76	19.30	29.71	37.08	36.83
LM-SF-8-4N	1/2	12.70	1/4	7.11	13/16	20.64	7/8	22.22	22.86	21.84	25.90	36.06	28.30
LM-SF-8-6N	1/2	12.70	3/8	9.65	13/16	20.64	7/8	22.22	22.86	21.84	25.90	36.06	28.30
LM-SF-8-8N	1/2	12.70	1/2	10.41	13/16	20.64	7/8	22.22	22.86	21.84	25.90	36.06	33.02
LM-SF-8-12N	1/2	12.70	3/4	10.41	1-1/16	26.98	7/8	22.22	22.86	21.84	29.71	39.87	36.83
LM-SF-10-6N	5/8	15.87	3/8	9.65	15/16	23.81	1	25.40	24.38	21.84	28.00	37.06	30.22
LM-SF-10-8N	5/8	15.87	1/2	11.93	15/16	23.81	1	25.40	24.38	21.84	28.00	37.06	35.10
LM-SF-10-12N	5/8	15.87	3/4	12.70	1-1/16	26.98	1	25.40	24.38	21.84	29.71	39.87	36.83
LM-SF-12-8N	3/4	19.05	1/2	11.93	1-1/16	26.98	1-1/8	28.57	24.38	21.84	29.71	39.87	37.00
LM-SF-12-12N	3/4	19.05	3/4	15.74	1-1/16	26.98	1-1/8	28.57	24.38	21.84	29.71	39.87	36.83
LM-SF-14-12N	7/8	22.22	3/4	15.74	1-1/4	31.75	1-1/4	31.75	25.90	21.84	34.54	44.70	41.65
LM-SF-16-12N	1	25.40	3/4	15.74	1-27-64	36.00	1-1/2	38.10	31.24	26.41	36.83	49.02	42.20
LM-SF-16-16N	1	25.40	1	22.35	1-27-64	36.00	1-1/2	38.10	31.24	26.41	36.83	49.02	46.70
LM-SF-20-20N	1-1/4	31.75	1-1/4	27.68	1-11/16	42.86	1-7/8	47.63	41.14	38.86	44.50	66.54	47.75
LM-SF-24-24N	1-1/2	38.10	1-1/2	34.03	2	50.80	2-1/4	57.15	50.03	45.21	50.80	77.97	60.45
LM-SF-32-32N	2	50.80	2	45.97	2-3/4	69.85	3	76.20	62.73	63.73	69.80	107.18	70.61

# TRM-SF Male Run Tee

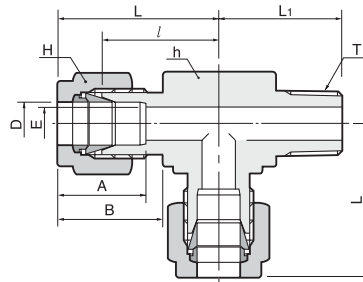

## Tube to Male NPT Run Tee

Part No.	Tube O.D.		T (NPT)	E Min.	Width across flat				A	B	l	L	L <sub>1</sub>
	in	mm			h	mm	H	mm					
TRM-SF -1-1N	1/16	1.59	1/16	1.27	7/16	11.11	5/16	7.93	8.63	10.92	15.24	19.05	17.78
TRM-SF -1-2N	1/16	1.59	1/8	1.27	7/16	11.11	5/16	7.93	8.63	10.92	15.24	19.05	17.78
TRM-SF -2-2N	1/8	3.17	1/8	2.28	1/2	12.70	7/16	11.11	12.70	15.24	18.30	24.91	18.90
TRM-SF -2-4N	1/8	3.17	1/4	2.28	1/2	12.70	7/16	11.11	12.70	15.24	18.30	24.91	23.36
TRM-SF -3-2N	3/16	4.76	1/8	3.04	1/2	12.70	1/2	12.70	13.71	16.00	18.79	24.38	18.79
TRM-SF -3-4N	3/16	4.76	1/4	3.04	1/2	12.70	1/2	12.70	13.71	16.00	18.79	25.40	23.36
TRM-SF -4-1N	1/4	6.35	1/16	3.04	1/2	12.70	9/16	14.28	15.24	17.78	19.55	26.90	18.79
TRM-SF -4-2N	1/4	6.35	1/8	4.82	1/2	12.70	9/16	14.28	15.24	17.78	19.55	26.92	18.79
TRM-SF -4-4N	1/4	6.35	1/4	4.82	1/2	12.70	9/16	14.28	15.24	17.78	19.55	27.08	23.87
TRM-SF -4-6N	1/4	6.35	3/8	4.82	11/16	17.46	9/16	14.28	15.24	17.78	22.35	29.71	28.40
TRM-SF -4-8N	1/4	6.35	1/2	4.82	13/16	20.64	9/16	14.28	15.24	17.78	24.60	31.97	35.10
TRM-SF -5-2N	5/16	7.93	1/8	4.82	9/16	14.28	5/8	15.87	16.25	18.54	22.35	29.71	19.81
TRM-SF -5-4N	5/16	7.94	1/4	6.35	9/16	14.28	5/8	15.87	16.25	18.54	22.35	29.77	24.50
TRM-SF -5-6N	5/16	7.94	3/8	6.35	11/16	17.46	5/8	15.87	16.25	18.54	23.11	30.48	28.40
TRM-SF -6-4N	3/8	9.52	1/4	7.11	5/8	15.87	1/16	17.46	16.76	19.30	23.11	30.48	25.40
TRM-SF -6-6N	3/8	9.52	3/8	7.11	11/16	17.46	11/16	17.46	16.76	19.30	23.87	31.24	28.44
TRM-SF -6-8N	3/8	9.52	1/2	7.11	13/16	20.64	11/16	17.46	16.76	19.30	25.90	33.27	33.02
TRM-SF -6-12N	3/8	9.52	3/4	7.11	1-1/16	26.98	11/16	17.46	16.76	19.30	29.71	37.08	36.83
TRM-SF -8-4N	1/2	12.70	1/4	7.11	13/16	20.64	7/8	22.22	22.86	21.84	25.90	36.06	28.30
TRM-SF -8-6N	1/2	12.70	3/8	9.65	13/16	20.64	7/8	22.22	22.86	21.84	25.90	36.06	28.30
TRM-SF -8-8N	1/2	12.70	1/2	10.41	13/16	20.64	7/8	22.22	22.86	21.84	25.90	36.06	33.02
TRM-SF -8-12N	1/2	12.70	3/4	10.41	1-1/16	26.98	7/8	22.22	22.86	21.84	29.71	39.84	36.83
TRM-SF -10-6N	5/8	15.87	3/8	9.65	15/16	23.81	1	25.40	24.38	21.84	27.90	38.10	29.40
TRM-SF -10-8N	5/8	15.87	1/2	11.93	15/16	23.81	1	25.40	24.38	21.84	27.90	38.10	34.00
TRM-SF -10-12N	5/8	15.87	3/4	12.70	1-1/16	26.98	1	25.40	24.38	21.84	29.71	39.87	36.83
TRM-SF -12-8N	3/4	19.05	1/2	11.93	1-1/16	26.98	1-1/8	28.58	24.38	21.84	29.71	39.87	37.00
TRM-SF -12-12N	3/4	19.05	3/4	15.74	1-1/16	26.98	1-1/8	28.58	24.38	21.84	29.71	39.81	36.83
TRM-SF -14-12N	7/8	22.23	3/4	15.74	1-1/16	26.98	1-1/4	31.75	25.90	21.84	34.54	44.70	41.65
TRM-SF -16-12N	1	25.40	3/4	15.74	1-1/4	31.75	1-1/2	38.10	31.24	26.41	36.83	49.02	42.20
TRM-SF -16-16N	1	25.40	1	22.35	1-27/64	36.12	1-1/2	38.10	31.24	26.41	36.83	49.02	46.70
TRM-SF -20-20N	1-1/4	31.75	1-1/4	27.68	1-27/64	36.12	1-7/8	47.63	41.14	38.86	44.50	66.54	47.75
TRM-SF -24-24N	1-1/2	38.10	1-1/2	34.03	2	50.80	2-1/4	57.15	50.03	45.21	50.80	77.97	60.45
TRM-SF -32-32N	2	50.80	2	45.97	2-3/4	69.85	3	76.20	67.56	62.73	69.80	107.18	70.61

## TBM-SF Male Branch Tee

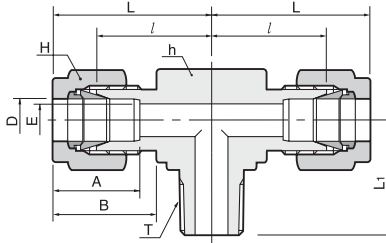

### Tube to Male NPT Branch Tee

Part No.	Tube O.D.		T (NPT)	E Min.	Width across flat				A	B	l	L	L <sub>1</sub>
	D in	mm			h in	mm	H in	mm					
TBM-SF -1-1N	1/16	1.59	1/16	1.27	7/16	11.11	5/16	7.93	8.63	10.92	15.24	19.05	17.78
TBM-SF -1-2N	1/16	1.59	1/8	1.27	7/16	11.11	5/16	7.93	8.63	10.92	15.24	19.05	17.78
TBM-SF -2-2N	1/8	3.17	1/8	2.28	1/2	12.70	7/16	11.11	12.70	15.24	18.30	24.91	18.90
TBM-SF -2-4N	1/8	3.17	1/4	2.28	1/2	12.70	7/16	11.11	12.70	15.24	18.30	24.91	23.36
TBM-SF -3-2N	3/16	4.76	1/8	3.04	1/2	12.70	1/2	12.70	13.71	16.00	18.79	24.38	18.79
TBM-SF -3-4N	3/16	4.76	1/4	3.04	1/2	12.70	1/2	12.70	13.71	16.00	18.79	25.40	23.36
TBM-SF -4-1N	1/4	6.35	1/16	3.04	1/2	12.70	9/16	14.28	15.24	17.78	19.55	26.90	18.79
TBM-SF -4-2N	1/4	6.35	1/8	4.82	1/2	12.70	9/16	14.28	15.24	17.78	19.55	26.92	19.10
TBM-SF -4-4N	1/4	6.35	1/4	4.82	1/2	12.70	9/16	14.28	15.24	17.78	19.55	27.08	23.87
TBM-SF -4-6N	1/4	6.35	3/8	4.82	11/16	17.46	9/16	14.28	15.24	17.78	22.35	29.71	28.40
TBM-SF -4-8N	1/4	6.35	1/2	4.82	13/16	20.64	9/16	14.28	15.24	17.78	24.60	31.97	35.10
TBM-SF -5-2N	5/16	7.93	1/8	4.82	9/16	14.28	5/8	15.87	16.25	18.54	22.35	29.71	19.81
TBM-SF -5-4N	5/16	7.93	1/4	6.35	9/16	14.28	5/8	15.87	16.25	18.54	22.35	29.77	24.50
TBM-SF -5-6N	5/16	7.93	3/8	6.35	11/16	17.46	5/8	15.87	16.25	18.54	23.11	30.48	28.40
TBM-SF -6-4N	3/8	9.52	1/4	7.11	5/8	15.87	11/16	17.46	16.76	19.30	23.11	30.48	25.40
TBM-SF -6-6N	3/8	9.52	3/8	7.11	11/16	17.46	11/16	17.46	16.76	19.30	23.87	31.24	28.44
TBM-SF -6-8N	3/8	9.52	1/2	7.11	13/16	20.64	11/16	17.46	16.76	19.30	25.90	33.27	33.02
TBM-SF -6-12N	3/8	9.52	3/4	7.11	1-1/16	26.98	11/16	17.46	16.76	19.30	29.71	37.08	36.83
TBM-SF -8-4N	1/2	12.70	1/4	7.11	13/16	20.64	7/8	22.22	22.86	21.84	25.90	36.06	28.30
TBM-SF -8-6N	1/2	12.70	3/8	10.41	13/16	20.64	7/8	22.22	22.86	21.84	25.90	36.06	28.30
TBM-SF -8-8N	1/2	12.70	1/2	10.41	13/16	20.64	7/8	22.22	22.86	21.84	25.90	36.06	33.02
TBM-SF -8-12N	1/2	12.70	3/4	10.41	1-1/16	26.98	7/8	22.22	22.86	21.84	29.71	39.87	36.83
TBM-SF -10-6N	5/8	15.87	3/8	9.65	15/16	23.81	1	25.40	24.38	21.84	27.90	38.10	29.40
TBM-SF -10-8N	5/8	15.87	1/2	11.93	15/16	23.81	1	25.40	24.38	21.84	27.90	38.10	34.00
TBM-SF -10-12N	5/8	15.87	3/4	12.70	1-1/16	26.98	1	25.40	24.38	21.84	29.71	39.87	36.83
TBM-SF -12-8N	3/4	19.05	1/2	11.93	1-1/16	26.98	1-1/8	28.58	24.38	21.84	29.71	39.87	37.00
TBM-SF -12-12N	3/4	19.05	3/4	15.74	1-1/16	26.98	1-1/8	28.58	24.38	21.84	29.71	39.87	36.83
TBM-SF -14-12N	7/8	22.22	3/4	15.74	1-1/16	26.98	1-1/4	31.75	25.90	21.84	34.54	44.70	41.65
TBM-SF -16-12N	1	25.40	3/4	15.74	1-1/4	31.75	1-1/2	38.10	31.24	26.41	36.83	49.02	42.20
TBM-SF -16-16N	1	25.40	1	22.35	1-27/64	36.12	1-1/2	38.10	31.24	26.41	36.83	49.02	46.70
TBM-SF -20-20N	1-1/4	31.75	1-1/4	27.68	1-27-64	36.12	1-7/8	47.63	41.14	38.86	44.50	66.54	47.75
TBM-SF -24-24N	1-1/2	38.10	1-1/2	34.03	2	50.80	2-1/4	57.15	50.03	45.21	50.80	77.97	60.45
TBM-SF -32-32N	2	50.80	2	45.97	2-3/4	69.85	3	76.20	67.56	62.73	69.80	107.18	70.61

# CF-SF Female Connector

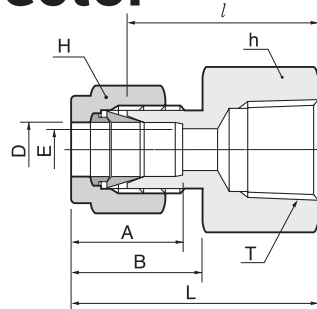

## Tube to Female NPT Connector

Part No.	Tube O.D.		T (NPT)	E Min.	Width across flat				A	B	l	L
	in	mm			h	mm	in	H				
CF-SF -1-1N	1/16	1.59	1/16	1.27	7/16	11.11	5/16	7.93	8.63	10.92	19.81	23.62
CF-SF -1-2N	1/16	1.59	1/8	1.27	9/16	14.28	5/16	7.93	8.63	10.92	20.57	24.38
CF-SF -2-2N	1/8	3.17	1/8	2.28	9/16	14.28	7/16	11.11	12.70	15.24	22.09	28.70
CF-SF -2-4N	1/8	3.17	1/4	2.28	3/4	19.05	7/16	11.11	12.70	15.24	26.92	33.52
CF-SF -3-2N	3/16	4.76	1/8	3.04	9/16	14.28	1/2	12.70	13.71	16.00	23.11	29.71
CF-SF -4-2N	1/4	6.35	1/8	4.82	9/16	14.28	9/16	14.28	15.24	17.78	23.87	31.24
CF-SF -4-4N	1/4	6.35	1/4	4.82	3/4	19.05	9/16	14.28	15.24	17.78	28.44	35.81
CF-SF -4-6N	1/4	6.35	3/8	4.82	7/8	22.22	9/16	14.28	15.24	17.78	30.22	37.59
CF-SF -4-8N	1/4	6.35	1/2	4.82	1-1/16	26.98	9/16	14.28	15.24	17.78	35.05	42.41
CF-SF -5-2N	5/16	7.93	1/8	6.35	9/16	14.28	5/8	15.87	16.25	18.54	24.63	32.00
CF-SF -5-4N	5/16	7.93	1/4	6.35	3/4	19.05	5/8	15.87	16.25	18.54	29.46	36.83
CF-SF -6-2N	3/8	9.52	1/8	7.11	5/8	15.87	11/16	17.46	16.76	19.30	25.40	32.76
CF-SF -6-4N	3/8	9.52	1/4	7.11	3/4	19.05	11/16	17.46	16.76	19.30	30.22	37.59
CF-SF -6-6N	3/8	9.52	3/8	7.11	7/8	22.22	11/16	17.46	16.76	19.30	31.75	39.11
CF-SF -6-8N	3/8	9.52	1/2	7.11	1-1/16	26.98	11/16	17.46	16.76	19.30	36.57	43.94
CF-SF -6-12N	3/8	9.52	3/4	7.11	1-5/16	33.33	11/16	17.46	16.76	19.30	40.38	47.75
CF-SF -8-4N	1/2	12.70	1/4	10.41	1-3/16	20.64	7/8	22.22	22.86	21.84	30.22	40.38
CF-SF -8-6N	1/2	12.70	3/8	10.41	7/8	22.22	7/8	22.22	22.86	21.84	31.75	41.91
CF-SF -8-8N	1/2	12.70	1/2	10.41	1-1/16	26.98	7/8	22.22	22.86	21.84	36.57	46.73
CF-SF -8-12N	1/2	12.70	3/4	10.41	1-5/16	33.33	7/8	22.22	22.86	21.84	38.10	48.26
CF-SF -10-6N	5/8	15.87	3/8	12.70	15/16	23.81	1	25.40	24.38	21.84	31.75	41.91
CF-SF -10-8N	5/8	15.87	1/2	12.70	1-1/16	26.98	1	25.40	24.38	21.84	36.57	46.73
CF-SF -10-12N	5/8	15.87	3/4	12.70	1-5/16	33.33	1	25.40	24.38	21.84	38.10	48.26
CF-SF -12-8N	3/4	19.05	1/2	15.74	1-1/16	26.98	1-1/8	28.58	24.38	21.84	36.57	46.73
CF-SF -12-12N	3/4	19.05	3/4	15.74	1-5/16	33.33	1-1/8	28.58	24.38	21.84	38.10	48.26
CF-SF -14-12N	7/8	22.22	3/4	18.28	1-5/16	33.33	1-1/4	31.75	25.90	21.84	39.62	49.78
CF-SF -16-12N	1	25.40	3/4	22.35	1-3/8	34.92	1-1/2	38.10	31.24	26.41	41.14	53.34
CF-SF -16-16N	1	25.40	1	22.35	1-5/8	41.27	1-1/2	38.10	31.24	26.41	50.03	62.23
CF-SF -20-20N	1-1/4	31.75	1-1/4	27.68	2-1/8	53.98	1-7/8	47.63	41.14	38.86	52.57	74.67
CF-SF -24-24N	1-1/2	38.10	1-1/2	34.03	2-3/8	60.33	2-1/4	57.15	50.03	45.21	56.13	83.31
CF-SF -32-32N	2	50.80	2	45.97	2-1/8	73.03	3	76.20	67.56	62.73	64.26	101.60

# CBF-SF Bulkhead Female Connector

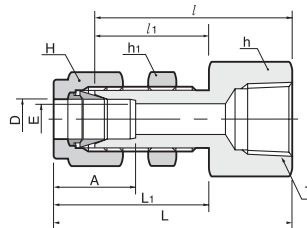

## Tube to Female NPT Bulkhead Connector

Part No.	Tube O.D.		T (NPT)	E Min.	Width across flat				A	l	l <sub>1</sub>	L	L <sub>1</sub>	Panel Hole Drill Size	Panel Max Thickness		
	in	mm			h	mm	h <sub>1</sub>	mm								H	mm
CBF-SF -2-2N	1/8	3.17	1/8	2.28	9/16	14.28	1/2	12.70	7/16	11.11	12.70	38.10	24.63	44.70	31.24	8.33	12.70
CBF-SF -4-2N	1/4	6.35	1/8	4.82	5/8	15.87	5/8	15.87	9/16	14.28	15.24	39.62	26.16	46.99	33.52	11.50	10.16
CBF-SF -4-4N	1/4	6.35	1/4	4.82	3/4	19.05	5/8	15.87	9/16	14.28	15.24	44.45	26.16	51.81	33.52	11.50	10.16
CBF-SF -6-4N	3/8	9.52	1/4	7.11	3/4	19.05	3/4	19.05	11/16	17.46	16.76	47.75	29.46	55.11	36.83	14.68	11.17
CBF-SF -6-6N	3/8	9.52	3/8	7.11	7/8	22.22	3/4	19.05	11/16	17.46	16.76	49.41	29.46	56.77	36.83	14.68	11.17
CBF-SF -8-6N	1/2	12.70	3/8	10.41	15/16	23.81	15/16	23.81	7/8	22.22	22.86	51.56	31.75	61.72	41.91	19.44	12.70
CBF-SF -8-8N	1/2	12.70	1/2	10.41	1-1/16	26.98	15/16	23.81	7/8	22.22	22.86	56.38	31.75	66.54	41.91	19.44	12.70
CBF-SF -12-12N	3/4	19.05	3/4	15.74	1-1/4	31.75	1-3/16	30.16	1-1/8	28.57	24.38	63.60	37.33	73.51	47.21	25.79	16.76
CBF-SF -16-16N	1	25.40	1	22.35	1-5/8	41.27	1-5/8	41.27	1-1/2	38.10	31.24	81.04	45.21	93.23	57.40	33.73	19.05
CBF-SF -20-20N	1-1/4	31.75	1-1/4	27.68	1-7/8	47.63	1-7/8	47.63	1-7/8	47.63	41.14	83.49	47.75	105.59	69.85	41.67	19.05
CBF-SF -24-24N	1-1/2	38.10	1-1/2	34.03	1-1/4	57.15	2-1/4	57.15	2-1/4	57.15	50.03	87.39	49.27	114.57	76.45	49.61	19.05
CBF-SF -32-32N	2	50.80	2	45.97	1-3/4	69.85	2-3/4	69.85	3	76.20	67.56	95.30	56.38	132.63	93.71	57.94	19.05

# LF-SF Female Elbow

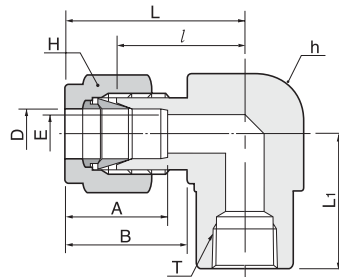

## Tube to Female NPT 90° Elbow

Part No.	Tube O.D.		T (NPT)	E Min.	Width across flat				A	B	l	L	L <sub>1</sub>
	in	mm			h	mm	H	mm					
LF-SF -2-2N	1/8	3.17	1/8	2.28	1/2	12.70	7/16	11.11	12.70	15.24	18.03	24.63	19.05
LF-SF -2-4N	1/8	3.17	1/4	2.28	11/16	17.46	7/16	11.11	12.70	15.24	20.82	27.43	22.35
LF-SF -3-2N	3/16	4.76	1/8	3.04	1/2	12.70	1/2	12.70	13.71	16.00	18.79	25.40	19.05
LF-SF -4-2N	1/4	6.35	1/8	4.82	1/2	12.70	9/16	14.28	15.24	17.78	19.55	26.92	19.05
LF-SF -4-4N	1/4	6.35	1/4	4.82	11/16	17.46	9/16	14.28	15.24	17.78	22.35	29.71	22.35
LF-SF -4-6N	1/4	6.35	3/8	4.82	13/16	20.64	9/16	14.28	15.24	17.78	24.38	31.75	22.35
LF-SF -4-8N	1/4	6.35	1/2	4.82	1	25.40	9/16	14.28	15.24	17.78	27.17	34.54	28.44
LF-SF -5-2N	5/16	7.93	1/8	6.35	9/16	14.28	5/8	15.87	16.25	18.54	21.33	28.70	19.05
LF-SF -5-4N	5/16	7.93	1/4	6.35	11/16	17.46	5/8	15.87	16.25	18.54	23.11	30.48	22.35
LF-SF -6-2N	3/8	9.52	1/8	7.11	5/8	15.87	11/16	17.46	16.76	19.30	23.11	30.48	19.05
LF-SF -6-4N	3/8	9.52	1/4	7.11	11/16	17.46	11/16	17.46	16.76	19.30	23.87	31.24	22.35
LF-SF -6-6N	3/8	9.52	3/8	7.11	13/16	20.64	11/16	17.46	16.76	19.30	25.90	33.27	22.35
LF-SF -6-8N	3/8	9.52	1/2	7.11	1	25.40	11/16	17.46	16.76	19.30	28.70	36.06	28.44
LF-SF -8-4N	1/2	12.70	1/4	10.41	13/16	20.64	7/8	22.22	22.86	21.84	25.90	36.06	22.35
LF-SF -8-6N	1/2	12.70	3/8	10.41	13/16	20.64	7/8	22.22	22.86	21.84	25.90	36.06	22.35
LF-SF -8-8N	1/2	12.70	1/2	10.41	1	25.40	7/8	22.22	22.86	21.84	28.70	38.86	28.44
LF-SF -10-6N	5/8	15.87	3/8	12.70	15/16	23.81	1	25.40	24.38	21.84	27.94	38.10	22.35
LF-SF -10-8N	5/8	15.87	1/2	12.70	1	25.40	1	25.40	24.38	21.84	29.71	39.87	28.44
LF-SF -12-8N	3/4	19.05	1/2	15.74	1-1/16	26.98	1-1/8	28.58	24.38	21.84	29.71	39.87	28.44
LF-SF -12-12N	3/4	19.05	3/4	15.74	1-1/4	31.75	1-1/8	28.58	24.38	21.84	34.54	44.70	31.75
LF-SF -14-12N	7/8	22.22	3/4	18.28	1-1/4	31.75	1-1/4	31.75	25.90	21.84	34.54	44.70	31.75
LF-SF -16-12N	1	25.40	3/4	22.35	1-27/64	36.00	1-1/2	38.10	31.24	26.41	36.83	49.02	31.75
LF-SF -16-16N	1	25.40	1	22.35	1-11/16	42.86	1-1/2	38.10	31.24	26.41	41.40	50.29	38.10



# TRF-SF Female Run Tee

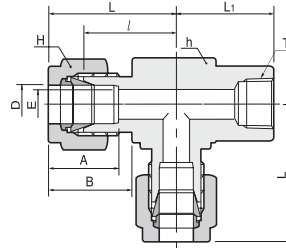

## Tube to Female NPT Run Tee

Part No.	Tube O D		T (NPT)	E Min.	Width across flat				A	B	l	L	L <sub>1</sub>
	D				h		H						
	in	mm			in	mm	in	mm					
TRF-SF -2-2N	1/8	3.17	1/8	2.28	1/2	12.70	7/16	11.11	12.70	15.24	18.03	24.63	19.05
TRF-SF -2-4N	1/8	3.17	1/4	2.28	11/16	17.46	7/16	11.11	12.70	15.24	20.82	27.43	22.35
TRF-SF -3-2N	3/16	4.76	1/8	3.04	1/2	12.70	1/2	12.70	13.71	16.00	18.79	25.40	19.05
TRF-SF -4-2N	1/4	6.35	1/8	4.82	1/2	12.70	9/16	14.28	15.24	17.78	19.55	26.92	19.05
TRF-SF -4-4N	1/4	6.35	1/4	4.82	11/16	17.46	9/16	14.28	15.24	17.78	22.86	29.71	22.35
TRF-SF -4-6N	1/4	6.35	3/8	4.82	13/16	20.64	9/16	14.28	15.24	17.78	24.38	31.75	22.35
TRF-SF -4-8N	1/4	6.35	1/2	4.82	1	25.40	9/16	14.28	15.24	17.78	27.17	34.54	28.44
TRF-SF -5-2N	5/16	7.94	1/8	6.35	9/16	14.28	5/8	15.87	16.25	18.54	21.33	28.70	19.05
TRF-SF -5-4N	5/16	7.94	1/4	6.35	11/16	17.46	5/8	15.87	16.25	18.54	23.11	30.48	22.35
TRF-SF -6-2N	3/8	9.52	1/8	7.11	5/8	15.87	11/16	17.46	16.76	19.30	23.11	30.48	19.05
TRF-SF -6-4N	3/8	9.52	1/4	7.11	11/16	17.46	11/16	17.46	16.76	19.30	23.87	31.24	22.35
TRF-SF -6-6N	3/8	9.52	3/8	6.35	13/16	20.64	11/16	17.46	16.76	19.30	25.90	33.27	22.35
TRF-SF -6-8N	3/8	9.52	1/2	7.11	1	25.40	11/16	17.46	16.76	19.30	28.70	36.06	28.44
TRF-SF -8-4N	1/2	12.70	1/4	10.41	13/16	20.64	7/8	22.22	22.86	21.84	25.90	36.06	22.35
TRF-SF -8-6N	1/2	12.70	3/8	10.41	13/16	20.64	7/8	22.22	22.86	21.84	25.90	36.06	22.35
TRF-SF -8-8N	1/2	12.70	1/2	10.41	1	25.40	7/8	22.22	22.86	21.84	29.71	39.87	28.44
TRF-SF -10-6N	5/8	15.87	3/8	12.70	15/16	23.81	1	25.40	24.38	21.84	27.94	38.10	22.35
TRF-SF -10-8N	5/8	15.87	1/2	12.70	1	25.40	1	25.40	24.38	21.84	28.70	38.86	28.44
TRF-SF -12-8N	3/4	19.05	1/2	15.74	1-1/16	26.98	1-1/8	28.58	24.38	21.84	29.71	39.87	28.44
TRF-SF -12-12N	3/4	19.05	3/4	15.74	1-1/4	31.75	1-1/8	28.58	24.38	21.84	34.54	44.70	31.75
TRF-SF -14-12N	7/8	22.22	3/4	18.28	1-1/4	31.75	1-1/4	31.75	31.75	21.84	34.54	44.70	31.75
TRF-SF -16-12N	1	25.40	3/4	22.35	1-27/64	36.12	1-1/2	38.10	38.10	26.41	36.83	49.02	31.75
TRF-SF -16-16N	1	25.40	1	22.35	1-1/16	42.86	1-1/2	38.10	38.10	26.41	41.40	50.29	38.10

# TBF-SF Female Branch Tee

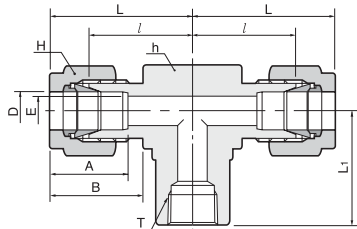

## Tube to Tube Female NPT Branch Tee

Part No.	Tube O.D. D		T (NPT)	E Min.	Width across flat				A	B	l	L	L <sub>1</sub>
	in	mm			h	H	in	mm					
TBF-SF -2-2N	1/8	3.17	1/8	2.28	1/2	12.70	7/16	11.11	12.70	15.24	18.03	24.38	19.05
TBF-SF -2-4N	1/8	3.17	1/4	2.28	11/16	17.46	7/16	11.11	12.70	15.24	20.82	27.43	22.35
TBF-SF -3-2N	3/16	4.76	1/8	3.04	1/2	12.70	1/2	12.70	13.71	16.00	18.79	25.40	19.05
TBF-SF -4-2N	1/4	6.35	1/8	4.82	1/2	12.70	9/16	14.28	15.24	17.78	19.55	26.92	19.05
TBF-SF -4-4N	1/4	6.35	1/4	4.82	11/16	17.46	9/16	14.28	15.24	17.78	22.35	29.71	22.35
TBF-SF -4-6N	1/4	6.35	3/8	4.82	13/16	20.64	9/16	14.28	15.24	17.78	24.38	31.75	22.35
TBF-SF -4-8N	1/4	6.35	1/2	4.82	1	25.40	9/16	14.28	15.24	17.78	27.17	34.54	28.44
TBF-SF -5-2N	5/16	7.94	1/8	6.35	9/16	14.28	5/8	15.87	16.25	18.54	21.33	28.70	19.05
TBF-SF -5-4N	5/16	7.94	1/4	6.35	11/16	17.46	5/8	15.87	16.25	18.54	23.11	30.48	22.35
TBF-SF -6-2N	3/8	9.52	1/8	7.11	5/8	15.87	11/16	17.46	16.76	19.30	23.11	30.48	19.05
TBF-SF -6-4N	3/8	9.52	1/4	7.11	11/16	17.46	11/16	17.46	16.76	19.30	23.87	31.24	22.35
TBF-SF -6-6N	3/8	9.52	3/8	6.35	13/16	20.64	11/16	17.46	16.76	19.30	25.90	33.27	22.35
TBF-SF -6-8N	3/8	9.52	1/2	7.11	1	25.40	11/16	17.46	16.76	19.30	28.70	36.06	28.44
TBF-SF -8-4N	1/2	12.70	1/4	10.41	13/16	20.64	7/8	22.22	22.86	21.84	25.90	36.06	22.35
TBF-SF -8-6N	1/2	12.70	3/8	10.41	13/16	20.64	7/8	22.22	22.86	21.84	25.90	36.06	22.35
TBF-SF -8-8N	1/2	12.70	1/2	10.41	1	25.40	7/8	22.22	22.86	21.84	29.71	39.87	28.44
TBF-SF -10-6N	5/8	15.87	3/8	12.70	15/16	23.81	1	25.40	24.38	21.84	27.94	38.10	22.35
TBF-SF -10-8N	5/8	15.87	1/2	12.70	1	25.40	1	25.40	24.38	21.84	28.70	38.86	28.44
TBF-SF -12-8N	3/4	19.05	1/2	15.74	1-1/16	26.98	1-1/8	28.58	24.38	21.84	29.71	39.87	28.44
TBF-SF -12-12N	3/4	19.05	3/4	15.74	1-1/4	31.75	1-1/8	28.58	24.38	21.84	34.54	44.70	31.75
TBF-SF -14-12N	7/8	22.22	3/4	18.28	1-1/4	31.75	1-1/4	31.75	25.90	21.84	34.54	44.70	31.75
TBF-SF -16-12N	1	25.40	3/4	22.35	1-27/64	36.00	1-1/2	38.10	31.24	26.41	36.83	49.02	31.75
TBF-SF -16-16N	1	25.40	1	22.35	1-11/16	42.86	1-1/2	38.10	31.24	26.41	41.40	53.59	38.10

# R-SF Reducer

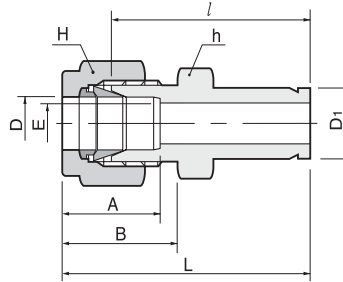

## Tube to Male Tube Stub Reducer

Part No.	Tube O.D.				E Min.	Width across flat				A	B	l	L
	D		D <sub>1</sub>			h		H					
	in	mm	in	mm		in	mm	in	mm				
R-SF -1-2	1/16	1.59	1/8	3.17	1.27	5/16	7.93	5/16	7.93	8.63	10.92	25.40	29.21
R-SF -1-4	1/16	1.59	1/4	6.35	1.27	5/16	7.93	5/16	7.93	8.63	10.92	27.68	31.49
R-SF -2-1	1/8	3.17	1/16	1.59	1.76	7/16	11.11	7/16	11.11	12.70	15.24	22.35	28.95
R-SF -2-2	1/8	3.17	1/8	3.17	2.03	7/16	11.11	7/16	11.11	12.70	15.24	26.92	33.52
R-SF -2-3	1/8	3.17	3/16	4.76	2.28	7/16	11.11	7/16	11.11	12.70	15.24	27.68	34.29
R-SF -2-4	1/8	3.17	1/4	6.35	2.28	7/16	11.11	7/16	11.11	12.70	15.24	29.46	36.06
R-SF -2-6	1/8	3.17	3/8	9.52	2.28	7/16	11.11	7/16	11.11	12.70	15.24	30.98	37.59
R-SF -2-8	1/8	3.17	1/2	12.70	2.28	9/16	14.28	7/16	11.11	12.70	15.24	37.59	44.19
R-SF -3-2	3/16	4.76	1/8	3.17	2.03	7/16	11.11	1/2	12.70	13.71	16.00	28.19	34.79
R-SF -3-4	3/16	4.76	1/4	6.35	3.04	7/16	11.11	1/2	12.70	13.71	16.00	30.48	37.08
R-SF -4-2	1/4	6.35	1/8	3.17	2.03	1/2	12.70	9/16	14.28	15.24	17.78	29.46	36.83
R-SF -4-3	1/4	6.35	3/16	4.76	3.04	1/2	12.70	9/16	14.28	15.24	17.78	30.22	37.59
R-SF -4-4	1/4	6.35	1/4	6.35	4.82	1/2	12.70	9/16	14.28	15.24	17.78	31.75	39.11
R-SF -4-5	1/4	6.35	5/16	7.93	4.82	1/2	12.70	9/16	14.28	15.24	17.78	32.51	39.87
R-SF -4-6	1/4	6.35	3/8	9.52	4.82	1/2	12.70	9/16	14.28	15.24	17.78	33.27	40.64
R-SF -4-8	1/4	6.35	1/2	12.70	4.82	9/16	14.28	9/16	14.28	15.24	17.78	38.86	46.22
R-SF -4-10	1/4	6.35	5/8	15.87	4.82	11/16	17.46	9/16	14.28	15.24	17.78	40.64	48.00
R-SF -4-12	1/4	6.35	3/4	19.05	4.82	13/16	20.64	9/16	14.28	15.24	17.78	40.38	47.75
R-SF -5-6	5/16	7.93	3/8	9.52	6.35	9/16	14.28	5/8	15.87	16.25	18.54	34.54	41.91
R-SF -5-8	5/16	7.93	1/2	12.70	6.35	9/16	14.28	5/8	15.87	16.25	18.54	40.13	47.49
R-SF -6-4	3/8	9.52	1/4	6.35	4.82	5/8	15.87	11/16	17.46	16.76	19.30	34.03	41.40
R-SF -6-6	3/8	9.52	3/8	9.52	7.11	5/8	15.87	11/16	17.46	16.76	19.30	35.81	43.18
R-SF -6-8	3/8	9.52	1/2	12.70	7.11	5/8	15.87	11/16	17.46	16.76	19.30	41.14	48.51
R-SF -6-10	3/8	9.52	5/8	15.87	7.11	11/16	17.46	11/16	17.46	16.76	19.30	42.92	50.29
R-SF -6-12	3/8	9.52	3/4	19.05	7.11	13/16	20.64	11/16	17.46	16.76	19.30	42.92	50.29
R-SF -8-4	1/2	12.70	1/4	6.35	4.82	13/16	20.64	7/8	22.22	22.86	21.84	34.79	44.95
R-SF -8-6	1/2	12.70	3/8	9.52	7.11	13/16	20.64	7/8	22.22	22.86	21.84	36.57	46.73
R-SF -8-8	1/2	12.70	1/2	12.70	9.90	13/16	20.64	7/8	22.22	22.86	21.84	42.16	52.32
R-SF -8-10	1/2	12.70	5/8	15.87	10.41	13/16	20.64	7/8	22.22	22.86	21.84	43.68	53.84
R-SF -8-12	1/2	12.70	3/4	19.05	10.41	13/16	20.64	7/8	22.22	22.86	21.84	43.68	53.84
R-SF -8-16	1/2	12.70	1	25.40	10.41	1-1/16	26.98	7/8	22.22	22.86	21.84	50.03	60.19
R-SF -10-12	5/8	15.87	3/4	19.05	12.70	15/16	23.81	1	25.40	24.38	21.84	44.45	54.61
R-SF -10-14	5/8	15.87	7/8	22.22	12.70	15/16	23.81	1	25.40	24.38	21.84	45.97	56.13
R-SF -10-16	5/8	15.87	1	25.40	12.70	1-1/16	26.98	1	25.40	24.38	21.84	50.80	60.96
R-SF -12-8	3/4	19.05	1/2	12.70	9.90	1-1/16	26.98	1-1/8	28.57	24.38	21.84	44.45	54.61
R-SF -12-16	3/4	19.05	1	25.40	15.74	1-1/16	26.98	1-1/8	28.57	24.38	21.84	52.32	62.48
R-SF -16-20	1	25.40	1-1/4	31.75	22.35	1-3/8	34.93	1-1/2	38.10	31.24	26.41	68.32	80.51
R-SF -16-24	1	25.40	1-1/2	38.10	22.35	1-5/8	41.28	1-1/2	38.10	31.24	26.41	76.96	89.15
R-SF -16-32	1	25.40	2	50.80	22.35	2-1/8	53.98	1-1/2	38.10	31.24	26.41	100.33	112.52
R-SF -20-24	1-1/4	31.75	1-1/2	38.10	27.68	1-7/8	47.63	2-1/4	57.15	41.14	38.86	82.04	104.14
R-SF -20-32	1-1/4	31.75	2	50.80	27.68	1-7/8	47.63	3	76.20	41.14	38.86	103.12	125.22
R-SF -24-32	1-1/2	38.10	2	50.80	34.03	2-1/4	57.15	3	76.20	50.03	45.21	104.14	131.31

# AB-SF Bulkhead Adaptor

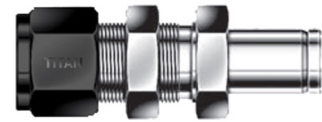
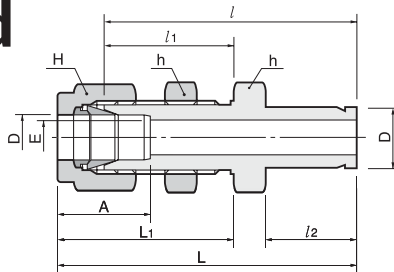

## Tube to Male Tube Stub Bulkhead Connector

Part No.	Tube O.D. D		E Min.	Width across flat				A	l	l <sub>1</sub>	l <sub>2</sub>	L	L <sub>1</sub>	Panel Hole Drill Size	Panel Max Thickness
	in	mm		h	mm	H	mm								
AB-SF -2-2	1/8	3.17	2.03	1/2	12.70	7/16	11.11	12.70	42.92	24.63	13.45	49.53	31.24	8.33	12.70
AB-SF -4-4	1/4	6.35	4.82	5/8	15.87	9/16	14.28	15.24	48.51	26.16	15.74	55.88	33.52	11.50	10.16
AB-SF -6-6	3/8	9.52	7.11	3/4	19.05	11/16	17.46	16.76	53.84	29.46	17.50	61.21	36.83	14.68	11.17
AB-SF -8-8	1/2	12.70	10.41	15/16	23.81	7/8	22.22	22.86	62.73	31.75	23.11	72.89	41.91	19.44	12.70
AB-SF -10-10	5/8	15.87	12.70	1-1/16	26.98	1	25.40	24.38	65.02	32.51	24.70	75.18	42.67	22.62	12.70
AB-SF -16-16	1	25.40	20.32	1-5/8	41.28	1-1/2	38.10	31.24	88.13	45.21	31.70	100.33	57.40	33.73	19.05
AB-SF -20-20	1-1/4	31.75	27.68	1-7/8	47.63	1-7/8	47.63	41.14	102.07	47.75	40.00	124.17	69.85	41.67	19.05
AB-SF -24-24	1-1/2	38.10	34.03	2-1/4	57.15	2-1/4	57.15	50.03	118.33	49.27	51.50	145.51	76.45	49.61	19.05
AB-SF -32-32	2	50.80	45.97	2-3/4	69.85	3	76.20	67.56	148.79	56.38	68.40	185.82	93.71	57.94	19.05

# AM-SF Male Adaptor

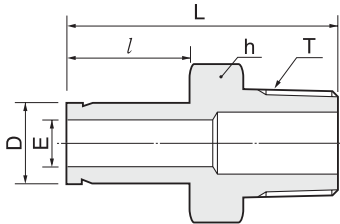

## Male Tube Stub to Male NPT Adaptor

Part No.	Tube O.D.		T (NPT)	E Min.	Width across flat		l	L
	D in	mm			h in	mm		
AM-SF -2-2N	1/8	3.17	1/8	2.03	7/16	11.11	13.45	29.50
AM-SF -2-4N	1/8	3.17	1/4	2.03	9/16	14.28	13.45	34.80
AM-SF -3-2N	3/16	4.76	1/8	3.04	7/16	11.11	14.20	30.22
AM-SF -3-4N	3/16	4.76	1/4	3.04	9/16	14.28	14.20	35.56
AM-SF -4-2N	1/4	6.35	1/8	4.31	7/16	11.11	15.75	31.80
AM-SF -4-4N	1/4	6.35	1/4	4.31	9/16	14.28	15.75	37.08
AM-SF -4-6N	1/4	6.35	3/8	4.31	11/16	17.46	15.75	37.84
AM-SF -4-8N	1/4	6.35	1/2	4.31	7/8	22.22	15.75	43.43
AM-SF -5-2N	5/16	7.93	1/8	5.58	7/16	11.11	16.80	32.76
AM-SF -5-4N	5/16	7.93	1/4	5.58	9/16	14.28	16.80	38.10
AM-SF -6-2N	3/8	9.52	1/8	6.86	7/16	11.11	17.50	33.50
AM-SF -6-4N	3/8	9.52	1/4	6.86	9/16	14.28	17.50	38.90
AM-SF -6-6N	3/8	9.52	3/8	6.86	11/16	17.46	17.50	39.60
AM-SF -6-8N	3/8	9.52	1/2	6.86	7/8	22.22	17.50	45.20
AM-SF -8-4N	1/2	12.70	1/4	9.40	9/16	14.28	23.20	44.50
AM-SF -8-6N	1/2	12.70	3/8	9.40	11/16	17.46	23.20	45.20
AM-SF -8-8N	1/2	12.70	1/2	9.40	7/8	22.22	23.20	50.50
AM-SF -10-6N	5/8	15.87	3/8	11.90	11/16	17.46	24.70	47.40
AM-SF -10-8N	5/8	15.87	1/2	11.90	7/8	22.22	24.70	52.30
AM-SF -10-12N	5/8	15.87	3/4	11.90	1-1/16	26.98	24.70	52.30
AM-SF -12-8N	3/4	19.05	1/2	14.73	7/8	22.22	24.70	52.30
AM-SF -12-12N	3/4	19.05	3/4	14.73	1-1/16	26.98	24.70	52.30
AM-SF -12-16N	3/4	19.05	1	14.73	1-3/8	34.92	24.70	57.91
AM-SF -14-12N	7/8	22.22	3/4	17.27	1-1/16	26.98	26.70	54.30
AM-SF -16-12N	1	25.40	3/4	20.32	1-1/16	26.98	31.70	58.70
AM-SF -16-16N	1	25.40	1	20.32	1-3/8	34.92	31.70	66.00
AM-SF -20-20N	1-1/4	31.75	1-1/4	25.90	1-3/4	44.45	40.00	80.26
AM-SF -24-24N	1-1/2	38.10	1-1/2	31.75	2-1/8	53.98	51.50	94.48
AM-SF -32-32N	2	50.80	2	43.68	2-3/4	69.85	68.40	119.38

# AF-SF Female Pipe Adaptor

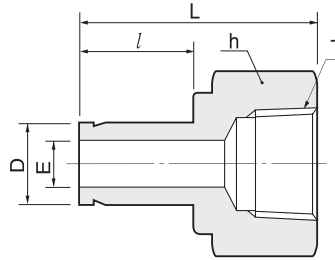

## Male Tube Stub to Female NPT Adaptor

Part No.	Tube O.D. D		T (NPT)	E Min.	Width across flat h		l	L
	in	mm			in	mm		
AF-SF -2-2N	1/8	3.17	1/8	2.03	9/16	14.28	13.45	31.50
AF-SF -2-4N	1/8	3.17	1/4	2.03	3/4	19.05	13.45	35.30
AF-SF -3-2N	3/16	4.76	1/8	3.04	9/16	14.28	14.20	32.00
AF-SF -3-4N	3/16	4.76	1/4	3.04	3/4	19.05	14.20	35.81
AF-SF -4-2N	1/4	6.35	1/8	4.31	9/16	14.28	15.75	33.02
AF-SF -4-4N	1/4	6.35	1/4	4.31	3/4	19.05	15.75	37.10
AF-SF -4-6N	1/4	6.35	3/8	4.31	7/8	22.22	15.75	39.37
AF-SF -4-8N	1/4	6.35	1/2	4.31	1-1/16	26.98	15.75	45.50
AF-SF -5-2N	5/16	7.93	1/8	5.58	9/16	14.28	16.80	34.29
AF-SF -5-4N	5/16	7.93	1/4	5.58	3/4	19.05	16.80	37.59
AF-SF -6-2N	3/8	9.52	1/8	6.86	9/16	14.28	17.50	34.29
AF-SF -6-4N	3/8	9.52	1/4	6.86	3/4	19.05	17.50	38.10
AF-SF -6-6N	3/8	9.52	3/8	6.86	7/8	22.22	17.50	40.38
AF-SF -6-8N	3/8	9.52	1/2	6.86	1-1/16	26.98	17.50	46.73
AF-SF -8-4N	1/2	12.70	1/4	9.4	3/4	19.05	23.20	43.43
AF-SF -8-6N	1/2	12.70	3/8	9.4	7/8	22.22	23.20	45.46
AF-SF -8-8N	1/2	12.70	1/2	9.4	1-1/16	26.98	23.20	51.80
AF-SF -10-6N	5/8	15.87	3/8	11.9	7/8	22.22	24.70	48.26
AF-SF -10-8N	5/8	15.87	1/2	11.9	1-1/16	26.98	24.70	53.84
AF-SF -10-12N	5/8	15.87	3/4	11.9	1-5/16	33.33	24.70	55.37
AF-SF -12-8N	3/4	19.05	1/2	14.73	1-1/16	26.98	24.70	52.83
AF-SF -12-12N	3/4	19.05	3/4	14.73	1-5/16	33.33	24.70	54.86
AF-SF -12-16N	3/4	19.05	1	14.73	1-5/8	41.27	24.70	58.42
AF-SF -14-12N	7/8	22.22	3/4	17.27	1-5/16	33.33	26.70	57.15
AF-SF -16-12N	1	25.40	3/4	20.32	1-5/16	33.33	31.70	60.70
AF-SF -16-16N	1	25.40	1	20.32	1-5/8	41.27	31.70	64.26
AF-SF -20-20N	1-1/4	31.75	1-1/4	25.9	2-1/8	53.98	40.00	77.72
AF-SF -24-24N	1-1/2	38.10	1-1/2	31.75	2-3/8	60.33	51.50	88.90
AF-SF -32-32N	2	50.80	2	43.68	2-7/8	73.03	68.40	107.44

# AG-SF Female BSPP Adaptor

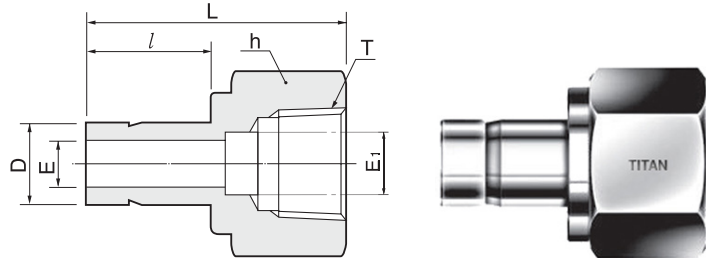

## Male Tube Stub to Female BSPP Adaptor

Part No.	Tube O.D.		T G(PF)	E Min.	E <sub>1</sub>	Width across flange		l	l <sub>1</sub>	L
	D					h				
	in	mm				in	mm			
AF-SF-4-2G	1/4	6.35	1/8	4.3	4.57	9/16	14.28	15.75	12	32
AF-SF-4-4G	1/4	6.35	1/4	4.3	5.5	3/4	19.05	15.75	12.9	35.3
AF-SF-6-6G	3/8	9.52	3/8	6.6	6.5	15/16	23.81	17.5	14.1	39.37
AF-SF-8-8G	1/2	12.7	1/2	7.1	7	1-1/16	26.98	23.2	18.9	45.72

## CP-SF Port Connector

### Male Tube Stub to Port Connector

Part No.	Tube O.D.		E Min.	D <sub>1</sub>	l	L
	D in	D mm				
CP-SF-1	1/16	1.59	1.00	3.30	10.66	13.72
CP-SF-2	1/8	3.17	2.03	6.09	15.75	22.35
CP-SF-4	1/4	6.35	4.31	9.39	18.79	24.64
CP-SF-5	5/16	7.93	5.58	10.92	20.06	25.90
CP-SF-6	3/8	9.52	6.86	12.70	20.32	26.16
CP-SF-8	1/2	12.70	9.4	15.74	25.90	35.81
CP-SF-12	3/4	19.05	14.73	22.09	27.68	37.33
CP-SF-16	1	25.40	20.32	28.44	34.54	48.00

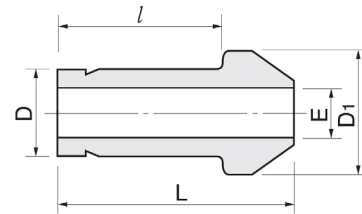

### Port Connector Installation Instructions:

1. Remove the nut and ferrules from valve or tube fitting body and set port connector in place of ferrule.
2. Slide tube nut over port connector shank
3. Tighten tube nut to finger tight then tighten using typical tube fitting installation method.

## CRP-SF Reducing Port Connector

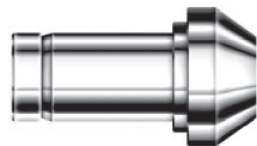
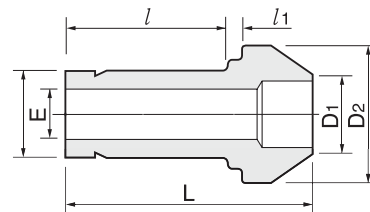

### Male Tube Stub to Reducing Port Connector

Part No.	Tube O.D.				E Min.	D <sub>2</sub>	l	l <sub>1</sub>	L
	D <sub>1</sub> in	D mm	D in	D mm					
CRP-SF-2-1	1/8	3.17	1/16	1.59	1.00	6.10	8.64	2.03	17.27
CRP-SF-4-2	1/4	6.35	1/8	3.17	2.28	9.39	13.45	3.30	22.60
CRP-SF-6-2	3/8	9.52	1/8	3.17	2.28	12.70	13.45	3.81	23.11
CRP-SF-6-4	3/8	9.52	1/4	6.35	4.82	12.70	15.75	3.30	24.89
CRP-SF-8-4	1/2	12.70	1/4	6.35	4.82	15.74	15.75	3.81	29.21
CRP-SF-8-6	1/2	12.70	3/8	9.52	7.11	15.74	17.50	3.30	30.48
CRP-SF-12-8	3/4	19.05	1/2	12.70	9.90	22.09	23.20	3.81	37.85
CRP-SF-16-8	1	25.40	1/2	12.70	9.90	28.40	24.47	4.82	42.67
CRP-SF-16-12	1	25.40	3/4	19.05	14.98	28.40	25.90	4.06	43.43



# UA-SF AN Union

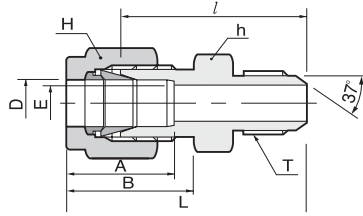

## Tube to Male JIC/AN Connector

Part No.	Tube O.D. D		AN Tube Flare Size		Straight Thread T(U)	E Min.	Width across flat				A	B	l	L
	in	mm	in	mm			h		H					
							in	mm	in	mm				
UA-SF-1-2	1/16	1.59	1/8	3.17	5/16-24	1.27	7/16	11.11	5/16	7.93	8.63	10.92	23.36	27.17
UA-SF-2-2	1/8	3.17	1/8	3.17	5/16-24	1.52	7/16	11.11	7/16	11.11	12.70	15.24	24.89	31.49
UA-SF-2-4	1/8	3.17	1/4	6.35	7/16-20	2.28	1/2	12.70	7/16	11.11	12.70	15.24	28.44	35.05
UA-SF-4-4	1/4	6.35	1/4	6.35	7/16-20	4.31	1/2	12.70	9/16	14.28	15.24	17.78	30.22	37.59
UA-SF-5-5	5/16	7.93	5/16	7.93	1/2-20	5.84	9/16	14.28	5/8	15.87	16.25	18.54	30.98	38.35
UA-SF-6-4	3/8	9.52	1/4	6.35	7/16-20	4.31	5/8	15.87	11/16	17.46	16.76	19.30	32.25	39.62
UA-SF-6-6	3/8	9.52	3/8	9.52	9/16-18	7.11	5/8	15.87	11/16	17.46	16.76	19.30	32.25	39.62
UA-SF-8-8	1/2	12.70	1/2	12.70	3/4-16	9.90	13/16	20.64	7/8	22.22	22.86	21.84	35.81	45.97
UA-SF-12-12	3/4	19.05	3/4	19.05	1-1/16-12	15.49	1-1/8	28.58	1-1/8	28.58	24.38	21.84	43.18	53.34
UA-SF-16-16	1	25.40	1	25.40	1-5/16-12	21.33	1-3/8	34.92	1-1/2	38.10	31.24	26.41	49.27	61.46
UA-SF-20-20	1-1/4	31.75	1-1/4	31.75	1-5/8-12	27.68	1-3/4	44.45	1-7/8	47.63	41.14	38.86	55.46	77.56
UA-SF-24-24	1-1/2	38.10	1-1/2	38.10	1-7/8-12	34.03	2-1/8	53.97	2-1/4	57.15	50.03	45.21	63.07	90.25
UA-SF-32-32	2	50.80	2	50.80	2-1/2-12	45.97	2-3/4	69.85	3	76.20	67.56	62.73	83.24	120.57

# UBA-SF AN Bulkhead Union

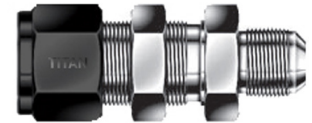
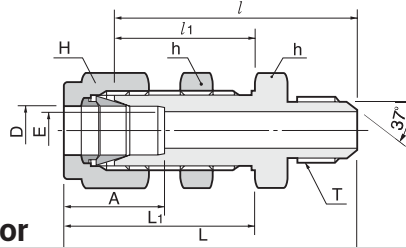

## Tube to Male JIC/AN Bulkhead Connector

Part No.	Tube O.D. D		AN Tube Flare Size		Straight Thread T(U)	E Min.	Width across flat				A	l	l <sub>1</sub>	L	L <sub>1</sub>	Panel Hole Drill Size	Panel Max Thickness
	in	mm	in	mm			h		H								
							in	mm	in	mm							
UBA-SF- 2-2	1/8	3.17	1/8	3.17	5/16-24	1.77	1/2	12.70	7/16	11.11	13.71	40.85	24.63	47.45	31.23	8.33	12.70
UBA-SF- 4-4	1/4	6.35	1/4	6.35	7/16-20	4.31	5/8	15.87	9/16	14.28	15.24	46.48	26.16	53.84	33.52	11.50	10.16
UBA-SF- 6-6	3/8	9.52	3/8	9.52	9/16-18	7.11	3/4	19.05	11/16	17.46	16.76	49.78	29.46	57.15	36.83	14.68	11.17
UBA-SF- 8-8	1/2	12.70	1/2	12.70	3/4-16	9.90	5/16	23.81	7/8	22.22	22.86	55.62	31.75	65.78	41.91	19.44	12.70
UBA-SF- 12-12	3/4	19.05	3/4	19.05	1-1/16-12	15.49	1-3/16	30.16	1-1/8	28.58	24.38	68.83	37.33	78.99	47.49	25.79	16.76
UBA-SF- 16-16	1	25.40	1	25.40	1-5/16-12	21.33	1-5/8	41.27	1-1/2	38.10	31.24	80.26	45.21	92.45	57.40	33.73	19.05
UBA-SF- 20-20	1-1/4	31.75	1-1/4	31.75	1-5/8-12	27.68	1-7/8	47.63	1-7/8	47.63	41.14	86.37	47.75	108.47	69.85	41.67	19.05
UBA-SF- 24-24	1-1/2	38.10	1-1/2	38.10	1-7/8-12	34.03	2-1/4	57.15	2-1/4	57.15	50.03	94.33	49.27	121.51	76.45	49.61	19.05
UBA-SF- 32-32	2	50.80	2	50.80	2-1/2-12	45.97	2-3/4	69.85	3	76.20	67.56	114.29	56.38	151.62	93.71	16.27	19.05

# AA-SF AN Adapter

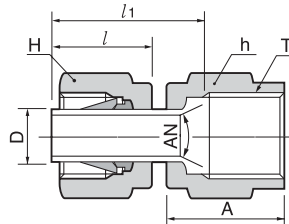

## Tube to Female JIC/AN Connector

Part No.	Tube O.D. D		AN Tube Flare Size		Straight Thread T(U)	Width across flat				A	l	l <sub>1</sub>
	in	mm	in	mm		h		H				
						in	mm	in	mm			
AA-SF-2-2	1/8	3.17	1/8	3.17	5/16-24	3/8	9.52	7/16	11.11	13.71	13.46	18.54
AA-SF-2-4	1/8	3.17	1/4	6.35	7/16-20	9/16	14.28	7/16	11.11	15.74	13.46	19.05
AA-SF-4-4	1/4	6.35	1/4	6.35	7/16-20	9/16	14.28	9/16	14.28	15.74	15.74	21.33
AA-SF-6-6	3/8	9.52	3/8	9.52	9/16-18	11/16	17.46	11/16	17.46	18.28	17.52	24.89
AA-SF-8-8	1/2	12.70	1/2	12.70	3/4-16	7/8	22.22	7/8	22.22	21.59	23.11	31.75

# MCS-SF SAE Male Connector

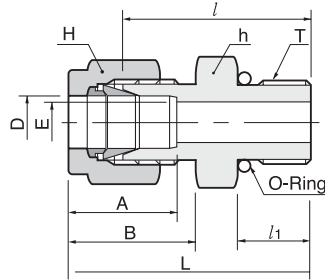

## Tube to Male SAE/ORB Connector

Part No.	Tube O.D. D		Straight Thread T(u)	E Min.	Width across flat				A	B	l	l <sub>1</sub>	L	O-Ring Uniform Size Number
	in	mm			h	H	in	mm						
MCS-SF -2-2U	1/8	3.17	5/16-24	2.28	7/16	11.11	7/16	11.11	12.70	15.24	23.26	7.62	29.97	-902
MCS-SF -4-4U	1/4	6.35	7/16-20	4.82	9/16	14.28	9/16	14.28	15.24	17.78	26.67	9.14	34.03	-904
MCS-SF -4-6U	1/4	6.35	9/16-18	4.82	11/16	17.46	9/16	14.28	15.24	17.78	28.19	9.90	35.56	-906
MCS-SF -4-8U	1/4	6.35	3/4-16	4.82	7/8	22.22	9/16	14.28	15.24	17.78	30.22	11.17	37.59	-908
MCS-SF -4-10U	1/4	6.35	7/8-14	4.82	1	25.40	9/16	14.28	15.24	17.78	33.27	12.70	40.64	-910
MCS-SF -5-5U	5/16	7.93	1/2-20	5.84	5/8	15.87	5/8	15.87	16.25	18.54	27.43	9.14	34.79	-905
MCS-SF -6-4U	3/8	9.52	7/16-20	5.08	5/8	15.87	11/16	17.46	16.76	19.30	28.19	9.14	35.56	-904
MCS-SF -6-6U	3/8	9.52	9/16-18	7.11	11/16	17.46	11/16	17.46	16.76	19.30	29.71	9.90	37.08	-906
MCS-SF -6-8U	3/8	9.52	3/4-16	7.11	7/8	22.22	11/16	17.46	16.76	19.30	31.75	11.17	39.11	-908
MCS-SF -6-10U	3/8	9.52	7/8-14	7.11	1	25.40	11/16	17.46	16.76	19.30	34.79	12.70	42.16	-910
MCS-SF -8-6U	1/2	12.70	9/16-18	7.11	13/16	20.64	7/8	22.22	22.86	21.84	28.95	9.90	39.11	-906
MCS-SF -8-8U	1/2	12.70	3/4-16	10.41	7/8	22.22	7/8	22.22	22.86	21.84	31.75	11.17	41.91	-908
MCS-SF -8-10U	1/2	12.70	7/8-14	10.41	1	25.40	7/8	22.22	22.86	21.84	34.79	12.70	44.95	-910
MCS-SF -8-12U	1/2	12.70	1-1/16-12	10.41	1-1/4	31.75	7/8	22.22	22.86	21.84	38.86	14.98	49.02	-912
MCS-SF -10-8U	5/8	15.87	3/4-16	10.66	15/16	23.81	1	25.40	24.38	21.84	31.75	11.17	41.91	-908
MCS-SF -10-10U	5/8	15.87	7/8-14	12.70	1	25.40	1	25.40	24.38	21.84	35.05	12.70	45.21	-910
MCS-SF -12-8U	3/4	19.05	3/4-16	10.66	1-1/16	26.98	1-1/8	28.57	24.38	21.84	35.81	11.17	45.97	-908
MCS-SF -12-12U	3/4	19.05	1-1/16-12	15.74	1-1/4	31.75	1-1/8	28.57	24.38	21.84	38.86	14.98	49.02	-912
MCS-SF -14-14U	7/8	22.22	1-3/16-12	18.28	1-3/8	34.92	1-1/4	31.75	25.90	21.84	38.86	14.98	49.02	-914
MCS-SF -16-12U	1	25.40	1-1/16-12	16.76	1-3/8	34.92	1-1/2	38.10	31.24	26.41	41.14	14.98	53.34	-912
MCS-SF -16-16U	1	25.40	1-5/16-12	22.35	1-1/2	38.10	1-1/2	38.10	31.24	26.41	42.16	14.98	54.35	-916
MCS-SF -20-20U	1-1/4	31.75	1-5/8-12	27.68	1-7/8	47.63	1-7/8	47.63	41.14	38.86	46.22	14.98	68.32	-920
MCS-SF -24-24U	1-1/2	38.10	1-7/8-12	34.03	2-1/8	53.98	2-1/4	57.15	50.03	45.21	50.54	14.98	77.72	-924
MCS-SF -32-32U	2	50.80	2-1/2-12	45.97	2-3/4	69.85	3	76.20	67.56	62.73	64.26	14.98	101.60	-932

# LS-SF Positionable SAE Male Elbow

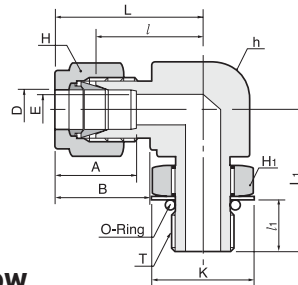

## Tube to Male SAE/ORB Positionable 90° Elbow

Part No.	Tube O.D. D		Straight Thread T(u)	E Min.	Width across flat					A	B	l	l <sub>1</sub>	L	L <sub>1</sub>	K	O-Ring Uniform Size Number	
	in	mm			h	H	H <sub>1</sub>	in	mm									in
LS-SF -4-4U	1/4	6.35	7/16-20	4.82	1/2	12.70	9/16	14.28	9/16	14.28	15.24	17.78	21.08	9.90	28.44	28.44	16.51	-904
LS-SF -5-5U	5/16	7.93	1/2-20	5.84	9/16	14.28	5/8	15.87	5/8	15.87	16.25	18.54	22.86	9.90	30.22	29.46	18.28	-905
LS-SF -6-6U	3/8	9.52	9/16-18	7.11	5/8	15.87	11/16	17.46	11/16	17.46	16.76	19.30	24.63	11.17	32.00	32.25	20.06	-906
LS-SF -6-8U	3/8	9.52	3/4-16	7.11	13/16	20.64	11/16	17.46	7/8	22.22	16.76	19.30	27.43	12.70	34.79	37.84	25.65	-908
LS-SF -8-8U	1/2	12.70	3/4-16	10.41	13/16	20.64	7/8	22.22	7/8	22.22	22.86	21.84	27.43	12.70	37.59	37.84	25.65	-908
LS-SF -10-10U	5/8	15.87	7/8-14	12.70	1	25.40	1	25.40	1	25.40	24.38	21.84	29.46	14.22	39.62	43.43	29.46	-910
LS-SF -12-12U	3/4	19.05	1-1/16-12	15.74	1-1/16	26.98	1-1/8	28.57	1-1/4	31.75	24.38	21.84	31.24	16.76	41.40	48.76	36.57	-912
LS-SF -14-14U	7/8	22.22	1-3/16-12	18.28	1-1/4	31.75	1-1/4	31.75	1-3/8	34.92	25.90	21.84	33.02	16.76	43.18	50.54	40.38	-914
LS-SF -16-16U	1	25.40	1-5/16-12	22.35	1-3/8	34.92	1-1/2	38.10	1-1/2	38.10	31.24	26.41	38.35	16.76	50.54	53.59	43.94	-916
LS-SF -20-20U	1-1/4	31.75	1-5/8-12	27.68	1-11/16	42.76	1-7/8	47.63	1-7/8	47.63	41.14	38.86	45.72	16.76	67.81	58.16	54.86	-920
LS-SF -24-24U	1-1/2	38.10	1-7/8-12	34.03	2	50.80	2-1/4	57.15	2-1/8	53.98	50.03	45.21	50.80	16.76	77.97	60.45	62.23	-924
LS-SF -32-32U	2	50.80	2-1/2-12	45.97	2-3/4	69.85	3	76.20	2-3/4	69.85	67.56	62.73	69.85	16.76	107.18	71.62	80.26	-932

# LBS-SF

## Positionable 45° SAE Male Elbow

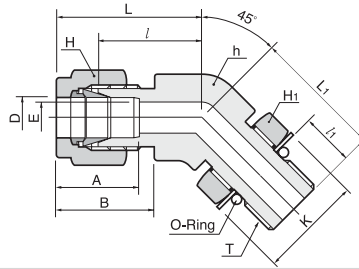

### Tube to Male SAE/ORB 45° Elbow

Part No.	Tube O.D. D		Straight Thread T(u)	E Min.	Width across flat			A	B	l	l <sub>1</sub>	L	L <sub>1</sub>	K	O-Ring Uniform Size Number			
	in	mm			h	H	H <sub>1</sub>											
LFS-SF -4-4U	1/4	6.35	7/16-20	4.82	1/2	12.70	9/16	14.28	9/16	14.28	15.24	17.78	18.28	9.90	25.65	25.65	16.51	-904
LFS-SF -6-6U	3/8	9.52	9/16-18	7.11	5/8	15.87	11/16	17.46	11/16	17.46	16.76	19.30	20.57	11.17	27.94	28.19	20.06	-906
LFS-SF -8-8U	1/2	12.70	3/4-16	10.41	13/16	20.64	7/8	22.22	7/8	22.22	22.86	21.84	21.84	12.70	32.00	32.25	25.65	-908
LFS-SF-1 2-12U	3/4	19.05	1-1/16-12	15.74	1-1/8	28.58	1-1/8	28.58	1-1/4	31.75	24.38	21.84	29.71	16.76	39.87	47.24	36.57	-912
LFS-SF -16-16U	1	25.40	1-5/16-12	22.35	1-3/8	34.92	1-1/2	38.10	1-1/2	38.10	31.24	26.41	35.30	16.76	47.49	50.54	43.94	-916

# TRS-SF

## Positionable SAE Male Run Tee

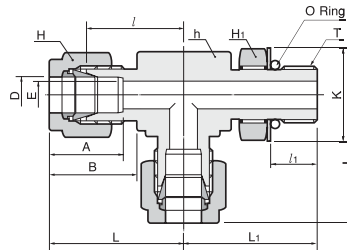

### Tube to Male SAE/ORB Run Tee

Part No.	Tube O.D. D		Straight Thread T(u)	E Min.	Width across flat			A	B	l	l <sub>1</sub>	L	L <sub>1</sub>	K	O-Ring Uniform Size Number			
	in	mm			h	H	H <sub>1</sub>											
TRS-SF- 4-4U	1/4	6.35	7/16-20	4.82	1/2	12.70	9/16	14.28	9/16	14.28	15.24	17.78	21.08	9.90	28.44	28.44	16.51	-904
TRS-SF- 6-6U	3/8	9.52	9/16-18	7.11	5/8	15.87	11/16	17.46	11/16	17.46	16.76	19.30	24.63	11.17	32.00	32.25	20.06	-906
TRS-SF- 8-8U	1/2	12.70	3/4-16	10.41	13/16	20.64	7/8	22.22	7/8	22.22	22.86	21.84	27.43	12.70	37.59	37.84	25.65	-908
TRS-SF- 12-12U	3/4	19.05	1-1/16-12	15.74	1-1/8	26.98	1-1/8	28.58	1-1/4	31.75	24.38	21.84	31.24	16.76	41.40	48.76	36.57	-912
TRS-SF- 16-16U	1	25.40	1-5/16-12	22.35	1-3/8	34.92	1-1/2	38.10	1-1/2	38.10	31.24	26.41	38.35	16.76	50.54	50.54	43.94	-916
TRS-SF- 20-20U	1-1/4	31.75	1-5/8-12	27.68	1-11/16	42.86	1-7/8	47.63	1-7/8	47.63	41.14	38.86	45.72	16.76	67.81	58.16	54.86	-920
TRS-SF- 24-24U	1-1/2	38.10	1-7/8-12	34.03	2	50.80	2-1/4	57.15	2-1/8	53.98	50.03	45.21	50.80	16.76	77.97	60.45	62.23	-924
TRS-SF- 32-32U	2	50.80	2-1/2-12	45.97	2-3/4	69.85	3	76.20	2-3/4	69.85	67.56	62.73	69.85	16.76	107.18	71.62	80.26	-932

# TBS-SF

## Positionable SAE Male Branch Tee

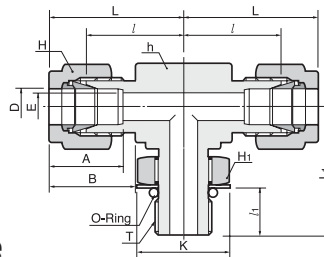

### Tube to SAE straight thread boss branch tee

Part No.	Tube O.D. D		Straight Thread T(u)	E Min.	Width across flat			A	B	l	l <sub>1</sub>	L	L <sub>1</sub>	K	O-Ring Uniform Size Number			
	in	mm			h	H	H <sub>1</sub>											
TBS-SF -4-4U	1/4	6.35	7/16-20	4.82	1/2	12.70	9/16	14.28	9/16	14.28	15.24	17.78	21.08	9.90	28.44	28.44	16.51	-904
TBS-SF -6-6U	3/8	9.52	9/16-18	7.11	5/8	15.87	11/16	17.46	11/16	17.46	16.76	19.30	24.63	11.17	32.00	32.25	20.06	-906
TBS-SF -8-8U	1/2	12.70	3/4-16	10.41	13/16	20.64	7/8	22.22	7/8	22.22	22.86	21.84	27.43	12.70	37.59	37.84	25.65	-908
TBS-SF -12-12U	3/4	19.05	1-1/16-12	15.74	1-1/8	26.98	1-1/8	28.58	1-1/4	31.75	24.38	21.84	31.24	16.76	41.40	48.76	36.57	-912
TBS-SF -16-16U	1	25.40	1-5/16-12	22.35	1-3/8	34.92	1-1/2	38.10	1-1/2	38.10	31.24	26.41	38.35	16.76	50.54	53.59	43.94	-916
TBS-SF -20-20U	1-1/4	31.75	1-5/8-12	27.68	1-11/16	42.86	1-7/8	47.63	1-7/8	47.63	41.14	38.86	45.72	16.76	67.81	58.16	54.86	-920
TBS-SF -24-24U	1-1/2	38.10	1-7/8-12	34.03	2	50.80	2-1/4	57.15	2-1/8	53.98	50.03	45.21	50.80	16.76	77.97	60.45	62.23	-924
TBS-SF -32-32U	2	50.80	2-1/2-12	45.97	2-3/4	69.85	3	76.20	2-3/4	69.85	67.56	62.73	69.85	16.76	107.18	71.62	80.26	-932

# COS-SF

## O-Seal Straight Thread Connector

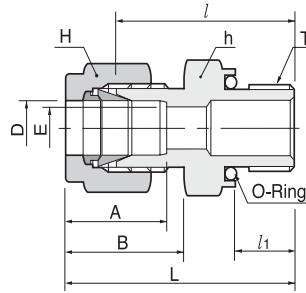

### Tube to Male SAE/ORB O-Seal Connector

Part No.	Tube O.D. D		Straight Thread T(u)	E Min.	Width across flat				A	B	l	l <sub>1</sub>	L	O-Ring Unifom Size Number
	in	mm			h	mm	in	mm						
COS-SF -2-2U	1/8	3.17	5/16-20	2.28	9/16	14.28	7/16	11.11	12.70	15.24	26.16	8.63	32.76	-011
COS-SF -3-3U	3/16	4.76	3/8-24	3.04	5/8	15.87	1/2	12.70	13.71	16.00	27.68	9.65	34.29	-012
COS-SF -4-4U	1/4	6.35	7/16-20	4.82	3/4	19.05	9/16	14.28	15.24	17.78	30.98	10.41	38.35	-111
COS-SF -5-5U	5/16	7.93	1/2-20	6.35	7/8	22.22	5/8	15.87	16.25	18.54	33.27	11.17	40.64	-112
COS-SF -6-6U	3/8	9.52	9/16-18	7.11	15/16	23.81	11/16	17.46	16.76	19.30	35.05	11.93	42.41	-113
COS-SF -8-8U	1/2	12.70	3/4-16	10.41	1-1/8	28.57	7/8	22.22	22.86	21.84	35.81	11.93	45.97	-116
COS-SF -12-12U	3/4	19.05	1-1/16-12	15.74	1-1/2	38.10	1-1/8	28.58	24.38	21.84	42.16	14.22	52.32	-215
COS-SF -16-16U	1	25.40	1-5/16-12	22.35	1-3/4	44.45	1-1/2	38.10	31.24	26.41	45.97	14.22	58.16	-219

# COP-SF

## O-Seal Pipe Thread Connector

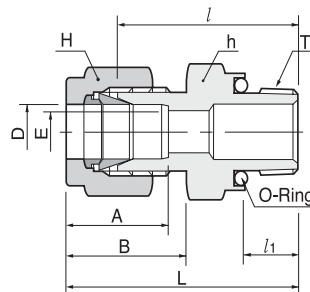

### Tube to Male NPT O-Seal Connector

Part No.	Tube O.D. D		T *(NPT)	E Min.	Width across flat				A	B	l	l <sub>1</sub>	L	O-Ring Unifom Size Number
	in	mm			h	mm	in	mm						
COP-SF -2-2N	1/8	3.17	1/8	2.28	3/4	19.05	7/16	11.11	12.70	15.24	26.16	7.11	32.76	-111
COP-SF -4-2N	1/4	6.35	1/8	4.82	3/4	19.05	9/16	14.28	15.24	17.78	27.68	7.11	35.05	-111
COP-SF -4-4N	1/4	6.35	1/4	4.82	15/16	23.81	9/16	14.28	15.24	17.78	30.98	9.65	38.35	-113
COP-SF -6-4N	3/8	9.52	1/4	7.11	15/16	23.81	11/16	17.46	16.76	19.30	32.51	9.65	39.87	-113
COP-SF -6-6N	3/8	9.52	3/8	7.11	1-1/8	28.58	11/16	17.46	16.76	19.30	34.03	10.41	41.40	-116
COP-SF -6-8N	3/8	9.52	1/2	7.11	1-5/16	33.33	11/16	17.46	16.76	19.30	39.62	13.46	46.99	-212
COP-SF -8-8N	1/2	12.70	1/2	10.41	1-5/16	33.33	7/8	22.22	22.86	21.84	39.62	13.46	49.78	-212

# CW-SF

## Male Pipe Weld Connector

### Tube to Male Weld Pipe Connector

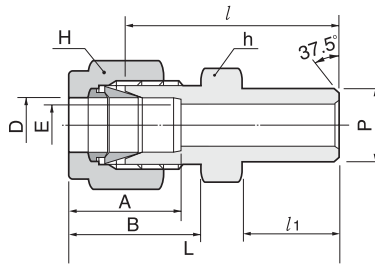

Part No.	Tube O.D.		Male Pipe Size		E Min.	Width across flat				A	B	l	l <sub>1</sub>	L
	D		P			h		H						
	in	mm	Nom.	O. D.		in	mm	in	mm					
CW-SF- 2-2P	1/8	3.17	1/8	10.29	2.28	7/16	11.11	7/16	11.11	12.70	15.24	23.87	9.65	31.24
CW-SF- 3-2P	3/16	4.76	1/8	10.29	3.04	7/16	11.11	1/2	12.70	13.71	16.00	24.63	9.65	31.24
CW-SF- 4-2P	1/4	6.35	1/8	10.29	4.82	1/2	12.70	9/16	14.28	15.24	17.78	25.40	9.65	32.76
CW-SF- 4-4P	1/4	6.35	1/4	13.72	4.82	9/16	14.28	9/16	14.28	15.24	17.78	30.48	14.22	37.84
CW-SF- 5-2P	5/16	7.93	1/8	10.29	5.08	9/16	14.28	5/8	15.87	16.25	18.54	26.67	9.65	34.03
CW-SF- 5-4P	5/16	7.93	1/4	13.72	6.35	9/16	14.28	5/8	15.87	16.25	18.54	31.24	14.22	38.60
CW-SF- 6-4P	3/8	9.52	1/4	13.72	7.11	5/8	15.87	11/16	17.46	16.76	19.30	32.51	14.22	39.87
CW-SF- 6-6P	3/8	9.52	3/8	17.15	7.11	11/16	17.46	11/16	17.46	16.76	19.30	32.51	14.22	39.87
CW-SF- 6-8P	3/8	9.52	1/2	21.34	7.11	7/8	22.22	11/16	17.46	16.76	19.30	38.86	19.05	46.33
CW-SF- 8-6P	1/2	12.70	3/8	17.15	10.41	13/16	20.64	7/8	22.22	22.86	21.84	33.27	14.22	43.43
CW-SF- 8-8P	1/2	12.70	1/2	21.34	10.41	7/8	22.22	7/8	22.22	22.86	21.84	38.86	19.05	49.02
CW-SF- 8-12P	1/2	12.70	3/4	26.67	10.41	1-1/16	26.98	7/8	22.22	22.86	21.84	40.38	19.05	50.54
CW-SF- 10-8P	5/8	15.87	1/2	21.34	12.70	15/16	23.81	1	25.40	24.38	21.84	38.86	19.05	49.02
CW-SF- 12-12P	3/4	19.05	3/4	26.67	15.74	1-1/16	26.98	1-1/8	28.58	24.38	21.84	40.38	19.05	50.54
CW-SF- 16-16P	1	25.40	1	33.40	22.35	1-3/8	34.92	1-1/2	38.10	31.24	26.41	50.03	23.87	62.23
CW-SF- 20-20P	1-1/4	31.75	1-1/4	42.16	27.68	1-3/4	44.45	2	50.80	41.14	38.86	55.11	23.87	77.21
CW-SF- 24-24P	1-1/2	38.10	1-1/2	48.26	34.03	2-1/8	53.98	2-1/4	57.15	50.03	45.21	61.72	26.16	88.90
CW-SF- 32-32P	2	50.80	2	60.33	47.75	2-3/4	69.85	3	76.20	67.56	62.73	76.20	26.92	113.53

# LW-SF

## Male Pipe Weld Elbow

### Tube to Male Weld Pipe 90° Elbow

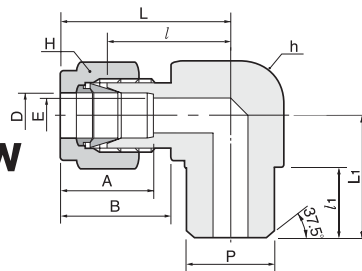

Part No.	Tube O.D.		Male Pipe Size		E Min.	Width across flat				A	B	l	l <sub>1</sub>	L	L <sub>1</sub>
	D		P			h		H							
	in	mm	Nom.	O. D.		in	mm	in	mm						
LW-SF-2-2 P	1/8	3.17	1/8	10.29	4.82	1/2	12.70	9/16	14.28	15.24	17.78	19.55	9.65	26.92	18.79
LW-SF-4-4 P	1/4	6.35	1/4	13.72	4.82	1/2	12.70	9/16	14.28	15.24	17.78	19.55	14.22	26.92	23.36
LW-SF-6-4 P	3/8	9.52	1/4	13.72	7.11	5/8	15.87	11/16	17.46	16.76	19.30	23.11	14.22	30.48	25.40
LW-SF-8-8 P	1/2	12.70	1/2	21.34	10.41	13/16	20.64	7/8	22.22	22.86	21.84	25.90	19.05	36.06	33.02
LW-SF-12-12P	3/4	19.05	3/4	26.67	15.74	1-1/16	26.98	1-1/8	28.58	24.38	21.84	29.71	19.05	39.87	36.83

## CSW-SF

### Tube Socket Weld Connector

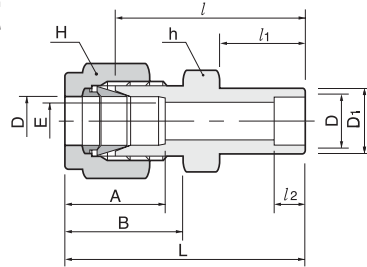

#### Tube to Male Socket Weld Connector

Part No.	Tube O. D. D		E Min.	D <sub>1</sub>	Width across flat				A	B	l	l <sub>1</sub>	l <sub>2</sub>	L
	in	mm			h	H	in	mm						
CSW-SF-2-2	1/8	3.17	2.28	7.87	7/16	11.11	7/16	11.11	12.70	15.24	22.35	8.63	6.35	28.95
CSW-SF-4-4	1/4	6.35	4.82	11.17	1/2	12.70	9/16	14.28	15.24	17.78	26.16	10.41	7.87	33.52
CSW-SF-6-6	3/8	9.52	7.11	15.74	5/8	15.87	11/16	17.46	16.76	19.30	30.22	11.93	9.65	37.59
CSW-SF-8-8	1/2	12.70	10.41	19.05	13/16	20.64	7/8	22.22	22.86	21.84	30.98	11.93	12.70	41.14
CSW-SF-12-1 2	3/4	19.05	15.74	26.67	1-1/16	26.98	1-1/8	28.58	24.38	21.84	33.27	11.93	14.22	43.43
CSW-SF-16-1 6	1	25.40	22.35	33.27	1-3/8	34.92	1-1/2	38.10	31.24	26.41	40.38	14.22	19.05	52.57

## LSW-SF

### Tube Socket Weld Elbow

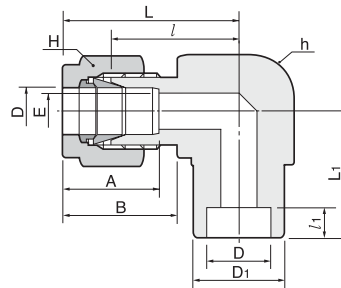

#### Tube to Male Socket Weld 90° Elbow

Part No.	Tube O. D. D		E Min.	D <sub>1</sub>	Width across flat				A	B	l	l <sub>1</sub>	L	L <sub>1</sub>
	in	mm			h	H	in	mm						
LSW-SF-4-4	1/4	6.35	4.82	12.70	1/2	12.70	9/16	14.28	15.24	17.78	19.55	7.87	26.92	19.55
LSW-SF-6-6	3/8	9.52	7.11	15.74	5/8	15.87	11/16	17.46	16.76	19.30	23.11	9.65	30.48	23.11
LSW-SF-8-8	1/2	12.70	10.41	20.57	13/16	20.64	7/8	22.22	22.86	21.84	25.90	12.70	36.06	25.90
LSW-SF-12-1 2	3/4	19.05	15.74	26.92	1-1/16	26.98	1-1/8	28.58	24.38	21.84	29.71	14.22	39.87	29.71
LSW-SF-16-1 6	1	25.40	22.35	35.05	1-3/8	34.93	1-1/2	38.10	31.24	26.41	36.83	19.05	49.02	36.83

# BUW-SF Welding Bulkhead Union

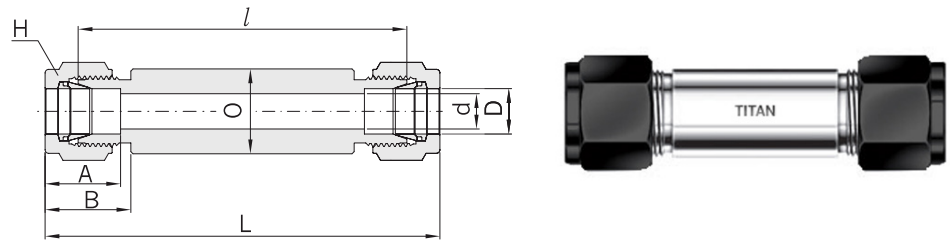

## Tube to Tube Welding Bulkhead Union

Part No.	Tube O.D.		d min	H		A	B	l	L	O
	in	mm		in	mm					
BUW-SF-1	1/16	1.59	1.27	5/16	7.93	8.63	10.92	64.2	71.85	10
BUW-SF-2	1/8	3.17	2.28	7/16	11.11	12.7	15.24	67.2	80.41	12
BUW-SF-3	3/16	4.76	3.04	7/16	11.11	13.71	16	69	82.2	12
BUW-SF-4	1/4	6.35	4.82	1/2	12.7	15.24	17.78	70.4	85.13	14
BUW-SF-5	5/16	7.93	6.35	9/16	14.28	16.25	18.54	73.7	88.43	16
BUW-SF-6	3/8	9.52	7.11	5/8	15.87	16.76	19.3	73.7	88.43	19
BUW-SF-8	1/2	12.7	10.41	13/16	20.64	22.86	21.84	73.7	94.02	23
BUW-SF-10	5/8	15.87	12.7	15/16	23.81	24.38	21.84	73.7	94.02	28
BUW-SF-12	3/4	19.05	15.74	11/16	26.98	24.38	21.84	73.7	94.02	32
BUW-SF-14	7/8	22.22	18.28	13/16	30.16	25.9	21.84	73.7	94.02	32
BUW-SF-16	1	25.4	22.35	13/8	34.92	31.24	26.41	78.5	102.89	35
BUW-SF-20	1-1/4	31.75	27.68	13/4	44.45	41.14	38.86	83.9	128.1	50
BUW-SF-24	1-1/2	38.1	34.03	21/8	53.97	50.03	45.21	86.1	140.45	55
BUW-SF-32	2	50.8	45.97	23/4	69.85	67.56	62.73	100.9	175.55	80

## P-SF Plug



### Tube Plug

Part No.	Tube O.D.		Width across flat	
	D		H	
	in	mm	in	mm
P-SF-1	1/16	1.59	5/16	7.93
P-SF-2	1/8	3.17	7/16	11.11
P-SF-3	3/16	4.76	1/2	12.70
P-SF-4	1/4	6.35	9/16	14.28
P-SF-5	5/16	7.93	5/8	15.87
P-SF-6	3/8	9.52	11/16	17.46
P-SF-8	1/2	12.70	7/8	22.22
P-SF-10	5/8	15.87	1	25.40
P-SF-12	3/4	19.05	1-1/8	28.58
P-SF-14	7/8	22.22	1-1/4	31.75
P-SF-16	1	25.40	1-1/2	38.10
P-SF-20	1-1/4	31.75	1-7/8	47.63
P-SF-24	1-1/2	38.10	2-1/4	57.15
P-SF-32	2	50.80	3	76.20

## C-SF Cap

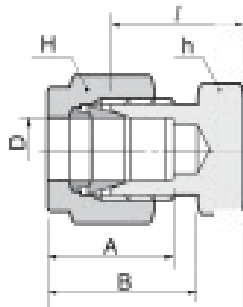

### Tube Cap

Part No.	Tube O.D.		Width across flat				A	B	l	L
	D		h		H					
	in	mm	in	mm	in	mm				
C-SF-1	1/16	1.59	5/16	7.93	5/16	7.93	8.63	10.92	11.20	14.18
C-SF-2	1/8	3.17	7/16	11.11	7/16	11.11	12.70	15.24	13.46	20.06
C-SF-3	3/16	4.76	7/16	11.11	1/2	12.70	13.71	16.00	14.73	21.33
C-SF-4	1/4	6.35	1/2	12.70	9/16	14.28	15.24	17.78	16.00	23.26
C-SF-5	5/16	7.93	9/16	14.28	5/8	15.87	16.25	18.54	17.01	24.38
C-SF-6	3/8	9.52	5/8	15.87	11/16	17.46	16.76	19.30	18.28	25.65
C-SF-8	1/2	12.70	13/16	20.63	7/8	22.22	22.86	21.84	19.05	29.21
C-SF-10	5/8	15.87	15/16	23.81	1	25.40	24.38	21.84	19.81	29.97
C-SF-12	3/4	19.05	1-1/16	26.98	1-1/8	28.57	24.38	21.84	21.33	31.49
C-SF-14	7/8	22.22	1-3/16	30.16	1-1/4	31.75	25.90	21.84	23.87	34.03
C-SF-16	1	25.40	1-3/8	34.92	1-1/2	38.10	31.24	26.41	26.16	38.35
C-SF-20	1-1/4	31.75	1-3/4	44.45	1-7/8	47.63	41.14	38.86	31.24	53.34
C-SF-24	1-1/2	38.10	2-1/8	53.98	2-1/4	57.15	50.15	45.21	37.33	64.51
C-SF-32	2	50.80	2-3/4	69.85	3	76.20	67.56	62.73	49.27	86.61



# I-SF Tube Insert

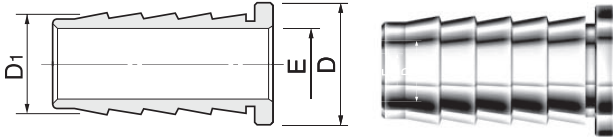

## Tube Fitting Insert

Part No.	Tube O.D.		Tube I.D.		E
	D		D <sub>1</sub>		
	in	mm	in	mm	
I-SF-3-2	3/16	4.76	1/8	3.17	2.28
I-SF-4-2	1/4	6.35	1/8	3.17	2.28
I-SF-4-3	1/4	6.35	3/16	4.76	3.55
I-SF-5-2	5/16	7.93	1/8	3.17	2.28
I-SF-5-3	5/16	7.93	3/16	4.76	3.04
I-SF-5-4	5/16	7.93	1/4	6.35	4.82
I-SF-6-3	3/8	9.52	3/16	4.76	3.04
I-SF-6-4	3/8	9.52	1/4	6.35	4.82
I-SF-8-4	1/2	12.7	1/4	6.35	4.82
I-SF-8-6	1/2	12.7	3/8	9.52	7.87
I-SF-10-6	5/8	15.87	3/8	9.52	7.87
I-SF-10-8	5/8	15.87	1/2	12.70	11.17
I-SF-12-8	3/4	19.05	1/2	12.70	11.17
I-SF-12-10	3/4	19.05	5/8	15.87	14.22
I-SF-16-12	1	25.4	3/4	19.05	17.52

# N-SF Nut

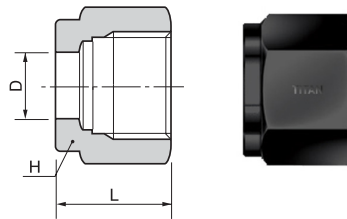

## Tube Nut

Part No.	Tube O.D.		Width across flat		L
	D		H		
	in	mm	in	mm	
N-SF-1	1/16	1.59	5/16	7.93	7.90
N-SF-2	1/8	3.17	7/16	11.11	11.93
N-SF-3	3/16	4.76	1/2	12.70	11.93
N-SF-4	1/4	6.35	9/16	14.28	12.70
N-SF-5	5/16	7.93	5/8	15.87	13.46
N-SF-6	3/8	9.52	11/16	17.46	14.22
N-SF-8	1/2	12.70	7/8	22.22	17.52
N-SF-10	5/8	15.87	1	25.40	17.52
N-SF-12	3/4	19.05	1-1/8	28.57	17.52
N-SF-14	7/8	22.22	1-1/4	31.75	17.52
N-SF-16	1	25.40	1-1/2	38.10	20.57
N-SF-20	1-1/4	31.75	1-7/8	47.63	31.75
N-SF-24	1-1/2	38.10	2-1/4	57.15	38.10
N-SF-32	2	50.80	3	76.20	52.32

## FO-SF Ferrule

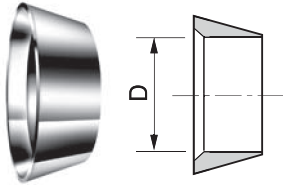

### Single Ferrule

Part No.	Tube O.D. D	
	in	mm
FO-SF- 1	1/16	1.59
FO-SF- 2	1/8	3.17
FO-SF- 3	3/16	4.76
FO-SF- 4	1/4	6.35
FO-SF- 5	5/16	7.93
FO-SF- 6	3/8	9.52
FO-SF- 8	1/2	12.70
FO-SF-10	5/8	15.87
FO-SF-12	3/4	19.05
FO-SF-14	7/8	22.22
FO-SF-16	1	25.40
FO-SF-20	1-1/4	31.75
FO-SF-24	1-1/2	38.10
FO-SF-32	2	50.80

## FS-SF Ferrule Set



### Single Ferrule Set

Part No.	Tube O.D. D	
	in	mm
FS-SF- 1	1/16	1.59
FS-SF- 2	1/8	3.17
FS-SF- 3	3/16	4.76
FS-SF- 4	1/4	6.35
FS-SF- 5	5/16	7.93
FS-SF- 6	3/8	9.52
FS-SF- 8	1/2	12.70
FS-SF-10	5/8	15.87
FS-SF-12	3/4	19.05
FS-SF-14	7/8	22.22
FS-SF-16	1	25.40

## INSTALLATION INSTRUCTIONS

---

TITAN tube fittings are precision-machined and designed to strict tolerances in order to achieve high performance and safe usage. The fittings are shipped and ready for installation on site without the use of any special tools or equipment.

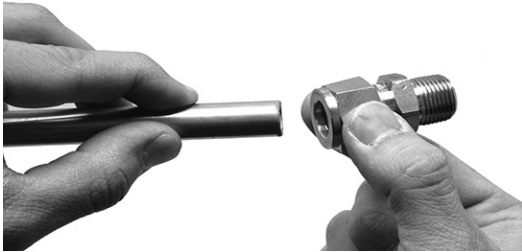

### STEP 1:

Insert properly cut tubing into tube nut until the tubing sits against the internal shoulder of the fitting. Hand tighten the nut until it stops. Mark this as position 6.

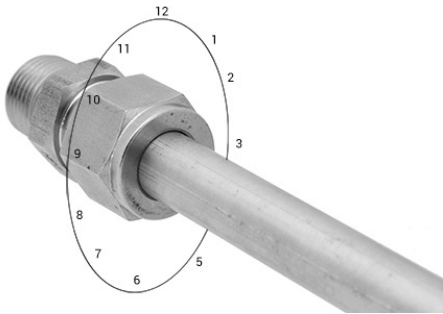

### STEP 2:

Secure the fitting and use a wrench to tighten the nut 1-1/4 turns past finger tight to position 9. For 1/16", 1/8" and 3/16" (or 2, 3, 4mm) tube fittings, tighten the nut only 3/4 turn to position 3.



### GAUGE CHECK:

Use an inspection gauge to insure proper tightening. If the inspection gauge cannot pass into the gap, proper tightening has been achieved.

### NOTES:

Select proper tubing for the application required  
Cut and prepare tubing properly before insertion into fittings

## TUBE FITTING REASSEMBLY:

---

Tube fittings can be reassembled and reused as long as there is not damage to the body, nut or ferrules. The components only need to be inspected and cleaned prior to reuse.

## TUBE HANDLING:

---

Tubing should be cut absolutely straight and without burrs before insertion. Tubing that does not slide properly may be deformed. Do not bend tubing after insertion into fittings as this may deform the connection.

## TUBING SAFETY CONSIDERATIONS:

---

Tubing will generally fail before fittings and valves, so proper care must be taking during tubing selection. Make sure tubing wall thickness, material, hardness, and standards are adequate to the needs of the fluid circuit system

## Tubing

Tubing is as critical component of a fluid circuit. Therefore it is important to select the appropriate tubing that is suitable to the application. Choose the proper tubing material and thickness before installation in order to create safe and high-performing fluid circuits.

### Notes :

- Use clean, scratch-free tubing without surface blemishes. Irregularities in the tubing will affect flow and can create pressure and temperature build up.
- If using welded tubing, make certain the beaded seam is polished to the same surface finish as the rest of the tubing wall.
- Match physical properties of the tubing to the fittings and valves in order to maintain a similar thermal stability coefficient.
- For tube fittings to properly compress onto tubing, the tubing material needs to be softer than the fitting ferrule material.
- Tubing hardness must be under HRB90 for stainless steel, under Rockwell 15T60 for copper tubing, and under HRB75 for Monel alloy 400.
- Select thickness of the tubing wall depending on pressures, shock, vibration, and temperature requirements.

## Temperature Ratings

The table below contains the maximum and minimum operating temperatures for the following tubing materials:

Tubing Material	Temperature Range
Stainless Steel 316	-321°F to 1200°F (-196°C to 649°C)
Carbon Steel	-65°F to 799°F (-53°C to 426°C)
Copper	-40°F to 400°F (-40°C to 205°C)
Alloy 400	-324°F to 800°F (-198°C to 427°C)
Alloy C276	-320°F to 1000°F (-195°C to 537°C)
Alloy 600	-205°F to 1200°F (-130°C to 648°C)
Titanium	-320°F to 600°F (-195°C to 315°C)
Teflon	0°F to 150°F (-17°C to 65°C)

## Seal Temperature Ratings

Fittings will have a different temperature rating depending on the material used. See table below for temperature rating of typical elastometric materials.

Elastomer seal material	Working Temperature
NBR (e. g. perbunan <sup>®</sup> )	-40°C to 110°C (-40°F to 230°F)
FKM (e. g. Viton <sup>®</sup> )	-28°C to 204°C (-20°F to 400°F)
PTFE (e. g. Teflon <sup>®</sup> )	-60°C to 204°C (-76°F to 464°F)

Working pressures are determined by operating temperatures. In order to determine the temperature-adjusted working pressure, multiply the working pressure at ambient temperature by the temperature de-rating factor in the table below.

Temp. °F (°C)	Stainless Steel ASTM A269 304 316	C.Steel ASTM A179	Copper ASTM B75	Alloy 400
100 (37)	1.00 1.00	1.00	1.00	1.00
200 (93)	1.00 1.00	0.95	0.80	0.88
300 (148)	1.00 1.00	0.90	0.78	0.82
400 (204)	0.93 0.96	0.86	0.50	0.79
500 (206)	0.87 0.90	0.82	0.13	0.79
600 (315)	0.82 0.85	0.77	-	0.79
700 (370)	0.80 0.82	0.73	-	0.76
800 (426)	0.76 0.79	0.59	-	0.76
900 (480)	0.73 0.78	-	-	-
1000 (537)	0.69 0.76	-	-	-
1200 (649)	0.30 0.37	-	-	-

## Tubing

Fully Annealed 304 or 316 high quality seamless steel tube to ASTM A269 or equivalent.  
Hardness Rb80 or less.

Stainless Steel Fractional Tubing																
Tube O.D (inches)	Tube Wall Thickness in Inches															
	0.010	0.0120	.014	0.0160	.020	0.0280	.0350	.049	0.0650	.083	0.0950	.109	0.1200	.1340	.156	0.188
1/16"	5,600	6,800	8,100	9,400	12,000											
1/8"						8,500	10,900									
3/16"						5,400	7,000	10,200								
1/4"						4,000	5,100	7,500	10,200							
5/16"							4,000	5,800	8,000							
3/8"							3,300	4,800	6,500							
1/2"	For gas service, applying					2,600	3,700	5,100	6,700							
5/8"	tube wall thickness should only						2,900	4,000	5,200	6,000						
3/4"	be selected from the outside of						2,400	3,300	4,200	4,900	5,800					
7/8"	the shaded boundary						2,000	2,800	3,600	4,200	4,800					
1"							2,400	3,100	3,600	4,200	4,700					
1 1/4"								2,400	2,800	3,300	3,600	4,100	4,900			
1 1/2"									2,300	2,700	3,000	3,400	4,000	4,900		
2"										2,000	2,200	2,500	2,900	3,600		

Stainless Steel Metric Tubing																
Tube O.D (mm)	Tube Wall Thickness in Inches															
	0.71 (0.028)	0.89 (0.035)	1.00	1.25 (0.049)	1.50	1.65 (0.065)	2.02	.11 (0.083)	2.41 (0.095)	2.50	2.77 (0.109)	3.003	.05 (0.120)	3.504	.004	.50
3	10,800	13,800	15,300													
4	7,900	10,100	11,500	14,400												
6	5,000	6,500	7,400	9,400	11,500	12,700										
8		4,700	5,800	6,800	8,400	9,300										
10		3,700	4,200	5,300	6,500	7,300										
12		3,000	3,400	4,400	5,300	5,900	6,600	7,000								
16			2,500	3,200	3,900	4,300	5,300	5,700	6,600	6,800						
18	For gas service,			2,800	3,400	3,800	4,700	5,000	5,800	6,000	6,700					
20	applying tube wall			2,500	3,000	3,400	4,200	4,400	5,100	5,300	6,000					
22	thickness should only			2,300	2,800	3,000	3,800	4,000	4,600	4,800	5,400					
25	be selected from the			2,000	2,400	2,700	3,300	3,500	4,000	4,200	4,700	5,100	5,200			
38	outside of the shaded boundary						2,300	-	2,900	-	3,400	3,900	4,400			

- For tubing/fitting usage in gas service applications, use tubing pressure only outside of shaded boundaries on above tables.
- Stated working pressures are based on the allowable stress value of 20,000 psi over a temperature range of -29°C to 37°C (-20°F to 100°F) specified by ASME [331.3-1999].
- Pressure calculations are based on maximum tubing O.D. and minimum wall thickness which is subject to change over usage and corrosive effects upon tubing.
- Safety factor = 3.75:1 ( considering ultimate tensile strength 75,000 psi)
- To Determine working pressures per ASME B31.1, multiply values by a factor of 0.94.

## NPT PIPE FITTINGS

TITAN tube fittings are often used with National Pipe Tapered (NPT) threaded fittings. It is important to note that these pipe fittings can have lower pressure ratings than the tube fittings in a fluid circuit.

Size Designator	ISO/NPT Pipe Size	Stainless Steel 316				Brass				Carbon Steel			
		Male		Female		Male		Female		Male		Female	
		psig	bar	psig	bar	psig	bar	psig	psig	psig	bar	psig	psig
1	1/16	11,000	758	6,700	462	5,500	379	3,300	227	11,000	758	6,700	462
2	1/8	10,000	689	6,500	448	5,000	345	3,200	221	10,000	689	6,500	448
4	1/4	8,000	551	6,600	455	4,000	276	3,300	227	8,000	551	6,600	455
6	3/8	7,800	538	5,300	365	3,900	269	2,600	179	7,800	538	5,300	365
8	1/2	7,700	531	4,900	338	3,800	262	2,400	165	7,700	531	4,900	338
12	3/4	7,300	503	4,600	317	3,600	248	2,300	159	7,300	503	4,600	317
16	1	5,300	365	4,400	303	2,600	179	2,200	152	5,300	365	4,400	303
20	1-1/4	6,000	414	5,000	345	3,000	207	2,500	172	6,000	414	5,000	345
24	1-1/2	5,000	345	4,600	317	2,500	172	2,300	159	5,000	345	4,600	317
32	2	3,900	269	3,900	269	1,900	131	1,900	131	3,900	269	3,900	269

The ratings are for reference only and are based on ASME B31.3-1999.

## NPT PIPE THREAD SEALANT

When using NPT threaded fittings in constructing a fluid circuit, it is critical to use pipe thread sealant or PTFE threaded tape to eliminate any potential leak paths in the NPT thread connection. If PTFE tape is used, the table below provides the recommended width of tape by fitting thread size.

Nominal Pipe Size	Recommended Tape Width	Effective Thread Length (External) L <sup>®</sup>	Approx.# of Thread
1/8	1/8-1/4	0.2639	7
1/4	1/4	0.4018	7-1/4
3/8	1/4	0.4075	7-1/3
1/2	1/4-1/2	0.5337	7-1/2
3/4	1/4-1/2	0.5457	7-2/3
1	1/4-1/2	0.6828	8

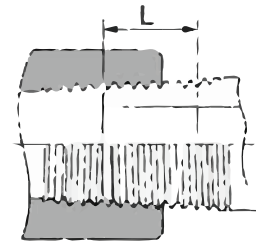

### NOTES:

Thread per ASME B1.20.1-NPT

Wrap the PTFE tape clockwise starting from the first thread. Be careful not to apply the tape over the edge of the thread as this may lead to the tape entering the fluid circuit path.

## Maximum Temperature by Materials

Aluminum	400 °F	204 °C
Copper	400 °F	204 °C
Steel	375 °F	191 °C
SUS304	1000 °F	538 °C
SUS316	1200 °F	649 °C
MONEL	800 °F	427 °C

Please refer to ASME B31.3-1993 concerning the detailed information about the maximum & minimum temperature of various materials.

## THREADS

### 1. NPT (National Pipe Thread)

Thread angle 60°

Tapered angle 1°47'

Manufactured by the standard of ANSI B2.1

### 2. ISO 7/1 Tapered Thread (BSPT)

Thread angle 55°

Tapered angle 1°47'

Equivalent to the standard of DIN2999 BS21 (BSPT) and JIS B0203 (PT).

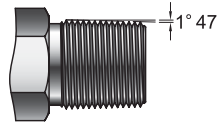

ISO Tapered  
(thread sealant required)

### 3. ISO 228/1 Parallel Thread (BSPP)

Thread angle 55°

Equivalent to the standard of BS 2779 (BSPP) and JIS B0202 (PF).

Use a gasket or O-ring to seal.

## The Recommended straight line length of tube in Tube Bending

Tube O.D. (inch)	1/8	3/16	1/4	5/16	3/8	1/2	5/8	3/4	7/8	1
Length L(mm)	12.70	18.25	19.05	20.63	22.20	23.81	30.16	31.75	33.30	38.10

- \*L: The straight line length of tubing from the ending part of tubing to the beginning part of bending
- \*Hardness: below HRb 75
- \*Tubing must be free from scars and shall be suitable for bending and expansion works.

## 1. Bonded Washer Seal

The bonded washer seal is crushed between the interface to create a seal between the hex of the male fitting shoulder and the lip of the female threaded fitting.

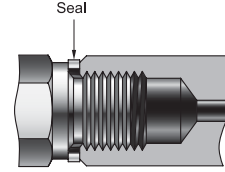

## 2. Metal Gasket Seal

Metal gasket seals are typically manufactured out of copper and are placed between the body of the male threaded fittings and the female fitting.

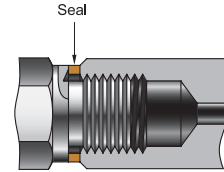

## 3. Metal Gasket Face Seal

This sealing mechanism uses a gasket between the face of the threaded male fitting and the bottom face of the female threaded fitting.

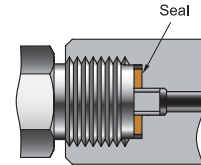

## 4. UNF Thread

•Thread angle 60°

•This is classified into UN, UNC and UNF. The standard is classified by the diameter of thread and the number of threads per inch.

## Tube material quality requirements

### Carbon Steel Tubing

- ASTM A179 or equivalent.
- Carbon steel tubing for an oil pressure usage of high quality, annealed and seamless
- Maximum hardness: HRb72
- Tubing must be free from scars and shall be suitable for bending and expansion works.

### Copper tubing

- ASTM B68, B75 or equivalent
- Copper tubing of high quality, annealed and seamless.

### Stainless Steel Tubing

- ASTM A213, A269 or equivalent.
- Stainless steel tubing of high quality, annealed and seamless (316, 304, 321, etc.)
- Hardness: below HRb 80
- Tubing must be free from scars and shall be suitable for bending and expansion works.

### Monel Tubing

- ASTM B165 or equivalent
- 400 alloy tubing of high quality annealed and seamless.

## Some of Our Other Products:



### Stainless Hose Fittings

- SS316 stainless across all styles
- Parker® and Eaton® interchangeable
- Full Material Test Report (MTR) available



### Adapters

- Instrumentation grade material and manufacturing
- Precision machined
- All North American and international thread types



### Hose Assemblies

- Large volume production capability
- Inspection report certificates available



### Double Ferrule

- Interchangeable with Swagelok® style fittings
- Simple installation and assembly

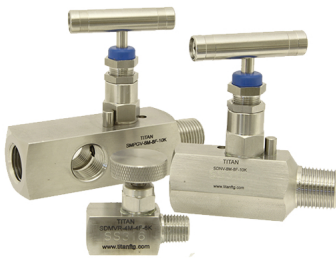

### Needle Valves

- 5000/6000/10000 pressure rated models
- standard PTFE, optional PEEK packing available
- Sour gas certified per NACE (if required)



### Check Valves

- 3000 and 6000 pressure rated models
- Available with NBR, Viton, and EPDM o-ring seals

